



**User's guide**  
**Naturall+**

Surgery and Prosthesis



**etk** is the result of 23 years of clinical applications and 27 years of research and development confirmed by valuable help of international research laboratories.

The design of our implants is based on the skills of our teams which are both reactive and experienced in implantology:

- ▶ Technical and biomechanical skills of our engineers enabling to guarantee the resistance of the component and their adaptation to the oral environment thanks to modern means of simulation.
- ▶ Biological and physiological skills of the associated laboratories enabling to validate the capacity of osseointegration of our systems.
- ▶ Clinical and practical skills of our dentists advisers ensuring the ergonomics of our products, the confirmation of our protocols and the ranges adapted to the various clinical cases.

**naturall+** implants are relied on the most new advanced scientific knowledge regarding implant treatment, which provides this implant an optimal capacity of anchoring with a strong osseointegration, in particular in the cortical bone area.

To enable you to take the best advantage of the **naturall+** implant, we created this manual with a professional care. We invite you to read it with your best attention. Each detail, even the least important, has its importance and underlines even more the difference between the beginner and the specialist.



<b>Warning</b>	<b>p. 6</b>
<b>General information</b>	<b>p. 7 to 9</b>
<b>Pre-implant study</b>	<b>p. 11 to 14</b>
<b>Surgical procedure</b>	<b>p. 15 to 38</b>
FOREWORD	P. 16
NATURALL+ IMPLANT	P. 18
KIT	
mini-kit	P. 22
complete kit	P. 23
PROTOCOL	
by bone density for the mini-kit	P. 23
by bone density for the complete kit	P. 25
step by step	P. 28
HEALING PROCESS	P. 36
<b>Impression techniques</b>	<b>p. 39 to 44</b>
WITH PICK-UP IMPRESSION COPING	P. 41
WITH POP-IN IMPRESSION COPING	P. 42
WITH POP-UP IMPRESSION COPING	P. 43
<b>Prosthetic procedure</b>	<b>p. 45 to 71</b>
FOREWORD	P. 46
CEMENTED PROSTHESIS	
on trans-screwed abutment	P. 47
on Direct Clip abutment	P. 51
ZIRCONIA PROSTHESIS	
on Esthetibase interface	P. 57
SCREWED PROSTHESIS	
on single-unit Tetra abutment	P. 62
on Tetra abutments	P. 64
on Plural abutments	P. 66
OVERDENTURE	
on O'Ring abutments	P. 70

**For more information on etk,  
implants, please visit our complete internet website,  
[www.etc.dental](http://www.etc.dental)**

## Warning

The placement of **etk** implants must be done by a practitioner who has been previously trained for the dental implantology techniques and in aseptic conditions specific to this type of treatment.

The following instructions will guide you throughout the different stages of your implantology treatments. They contain advice as precise as possible but cannot be used as «recipes», every clinical situation must be evaluated for each patient. A great number of factors acts independently to obtain success in an implantology treatment. It is up to the practitioner to recognize the key factors and to use his clinical experience. Among other aspects, the coordination between the prosthesis laboratory dental technician and the practitioner must be perfect so as to give the global treatment plan more consisting. Only the practitioner remains responsible for his different choices and decisions as to the treatment's feasibility, implants, prosthetic parts, materials used and settings... The technical specifications and clinical advice in this manual are given solely as a guideline and cannot give rise to any claims. All the essential information is indicated in the instruction for use supplied with products.

We have taken great care in the design and production of our products. However, we reserve the right to bring modifications or improvements arising from new technical developments in our implantology system. We will advise of any modifications having an implication in the operation mode. According to the importance of the modifications, a new manual will be issued. Indeed, a mark on the back page indicates the date of issue of your surgery manual, and enables us to check if you have the latest update version. You will also be able to access our web site to check the latest version of this manual.

The reproduction and distribution of all or part of this manual need previous agreement from **etk**.

# GENERAL INFORMATION

### naturall+ implant GENERAL INDICATIONS

The **etk** dental implants are suitable for oral bone implantation at the mandible and maxilla and for oral aesthetic restoration of fully or partially edentulous patients (except in the presence of specific indications and contra-indications hereinafter mentioned). **etk** dental implants can be used for differed, immediate or early loading after a tooth extraction or loss. **etk** implants are suitable, in the framework of their indications, for immediate restoration of fully or partially edentulous jaws.

A good primary stability and a suitable occlusal load are paramount. The healing duration for differed restorations is indicated at the corresponding chapter. Commonly used prosthetic restorations are single crowns, bridges and full or partial prosthesis, connected into the implants by prosthetic components specific to the implant being used. You will find at the following pages, for each implant, detailed information about the necessary bone volume, the space between two implants and the distance to respect with the adjacent tooth.

- ▶ Lack of retention of a prosthesis
- ▶ Instability of a prosthesis
- ▶ Functional discomfort with the prosthesis
- ▶ Psychological refusal of the wearing of a prosthesis
- ▶ Parafunctional practices which compromise the stability of a prosthesis
- ▶ Inadequate localization and number of remaining abutments
- ▶ Lack of dental abutment to perform a fixed prosthesis
- ▶ Edentulous area with healthy adjacent teeth
- ▶ Request for a treatment preserving the adjacent healthy teeth
- ▶ Dental agenesis
- ▶ Request for a preservation treatment (refusal of alteration of healthy teeth)

They are supra-crestal implants designed to be placed in two-steps surgery, with a Morse tapered connection. The immediate connection of an healing abutment will enable to work in one-step surgery.

The conical shape of **naturall+** implants and their «straight» neck are particularly adapted for:

- ▶ reduced mesio-distal spaces,
- ▶ post-extractional surgery,
- ▶ the management of the aesthetic in anterior area and enable to optimize the implantation.

The conical implant **naturall+** is very adapted for the post-extractional placement of implants and for the D3 - D4 bone type thanks to its excellent primary stability.

### Specific indications for 6 MM LONG IMPLANTS

As the anchorage surface of these implants is limited, they should be used only for the following indications:

- ▶ as complementary implants to longer implants in a multi-unit restoration,
- ▶ to support full prosthesis, in case of a very atrophied mandible,
- ▶ on implant sites of a bone quality higher to D4 according to the Misch classification.

### Contra indications to the use OF THE IMPLANTS (REMINDER)

#### Absolute contra indications

- ▶ severe medical diseases
- ▶ bone metabolism disorders
- ▶ uncontrolled hemorrhagic disorders
- ▶ healing disorders
- ▶ major psychological disorders
- ▶ functional disorders
- ▶ risky cardiopathy
- ▶ incomplete maxillary and mandible growth
- ▶ uncontrolled systemic pathology (endocrine diseases, xerostomy, allergy to titanium)
- ▶ infectious, hematological and immune pathology (immune disorder)
- ▶ alcoholism, medication or drug addiction (regular steroid use)

- ▶ patients with little motivation or cooperation
- ▶ age of the patient (young patient during growth)
- ▶ poor hygiene of the patient

#### Relative contra indications

- ▶ use of anticoagulants, hemorrhagic diathesis
- ▶ insufficient volume and / or an osseous quality
- ▶ a poor oral hygiene
- ▶ temporomandibular joint disorder
- ▶ an insufficient restorative space
- ▶ if a sinus lifting is needed with the implant
- ▶ a patient presenting risks (patient exposed to atomic radiation, bruxism, uncontrolled parodontitis, addiction to smoking)



## Guarantee

In case of non osseointegration, you must inform your commercial representative so that we can examine the causes for the failure and bring the necessary corrective actions. An exchange may take place when the defect of the product is established; if the failure results from an incorrect clinical analysis, a surgical protocol not adapted to the case, from the use of blunt drills...or for any other reason independent from the product quality, the guarantee will not be taken into consideration.

## Parts PACKAGING

### Sterility and rule of asepsis

- ▶ Most of our parts are delivered sterile and can therefore be used straightaway. A reference indicator shows the components effective sterility on the packaging. The sterility is guaranteed for 5 years (from packaging date). A standard expiry date is indicated on the label.
- ▶ Only an undamaged packaging can guarantee the products imperviousness and sterility. Do not use implants with packaging which has been damaged or prematurely opened.
- ▶ Our products have been designed so as to enable handling without affecting their sterility. It is therefore

important to follow a precise handling technique so as not to compromise the conventional hygiene conditions associated with the implant practice.

- ▶ The non-sterile instruments and items delivered used for the implantology treatment must be decontaminated and, according to a tested process, sterilized at the practice.

	Sterile	No sterile
Implants	X	
Cover screw (Supplied with implant)	X	
Drills		X

### Labels

Our implants are delivered with 2 principal labels and one removable label clearly showing the mark, the reference and the batch number (for a total of 3 labels):

- ▶ 2 labels for the patient's file of the practitioner who placed the implant and/or of the correspondent.
- ▶ 1 label for the patient.





 **Manufacturing**

 **Be careful see detailed description**

 **Date of manufacturing**

 **Use until**

 **See the instruction manual**

 **Product reference number**

 **Serial number**

 **Store in a dark place**

 **Store in a dry place**

 **Complying with European requirements directives regarding medical plan 93/42 CEE**

 **Don't use if the packing is damaged**

 **Sanitation method using radiation**

 **Don't reuse**

 **Don't sterilize twice**

## Storage OF THE PRODUCTS

The implants must be stored in a clean, dry and cool place.

## Precautionary MEASURES

- ▶ It is strongly advised to keep in stock implants which cover the most frequently used diameters as well as the different lengths.
- It is important to be able to change an implant's choice during a procedure, to replace an implant which has been contaminated for any reason, to insert an extra implant in certain cases to insure the long term treatment success...

- ▶ We recommend to use a safety thread on the instruments to avoid any accidental fall of tools in the patient's throat.
- ▶ It is strongly advised to prepare the receiving socket with **etk** instruments shown in this manual.



# PRE-IMPLANT **STUDY**

**IMPLANT treatment feasibility**

**This study takes different elements into consideration**

- ▶ A patient's questionnaire to reveal potential health medications problems which could have a bearing on the treatment success, alcohol, use of tobacco or drugs, general dental hygiene...
- ▶ An oral examination which will give details about the mouth opening, the ligne of the patient's smile (if is it a gingival smile), the coronary height and the volume of bone available, the type of occlusion...
- ▶ Biological tests (glycemy...)
- ▶ A complete X-Ray file showing the available bone's volumes.
- ▶ Complete tests studies with the two dental arches in occlusion.
- ▶ An implant treatment cannot be started without a thorough cleaning of all the patient's infectious seats.

**Guide for the IMPLANTS CHOICE**

**Available bone volume**

*In the mesio-distal plan*

- ▶ Leave 2 mm between the implant's thread and natural teeth.
- ▶ Leave 3 mm between the thread of two implants.

*In the labio-lingual palatal direction*

Leave, if possible, 1.5 to 2 mm of bone thickness around the labial, palatal & lingual surfaces.

	Naturall+				
Ø implant	● Ø 3	● Ø 3.5	● Ø 4	● Ø 4.5	● Ø 5
Ø neck	3.2	3.7	4.2	4.7	5.2

**Bone quality**

It is recommended to use larger implants in low density bones to compensate the reduced bone/implant surface contact.

	Recommended length	
Bone quality	D1	8 mm
	D2	10 mm
	D3	12 mm
	D4	12 mm

**The classification of osseous structures\***

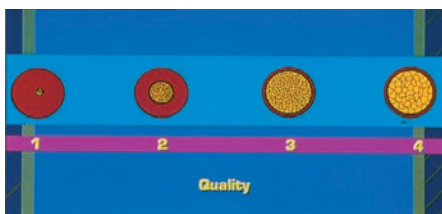

- 1: very high density of compact bone
- 2: thick layer of cortical bone around a dense core of spongy tissue
- 3: thin layer of cortical bone around a big core of spongy tissue
- 4: thin layer of cortical bone around a big core of low density of spongy tissue

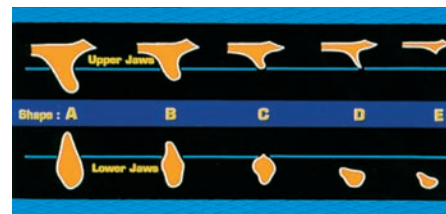

- A: important quality of remaining alveolar bone
- B: limited resorption of the alveolar bone crest
- C: important resorption of the alveolar bone crest
- D: beginning of the basal resorption bone
- E: important resorption of the basal bone

\* Misch, (1998) Lekholm and Zarb (1985), Classification of partially edentulous arches for implant dentistry.

## Maxillar

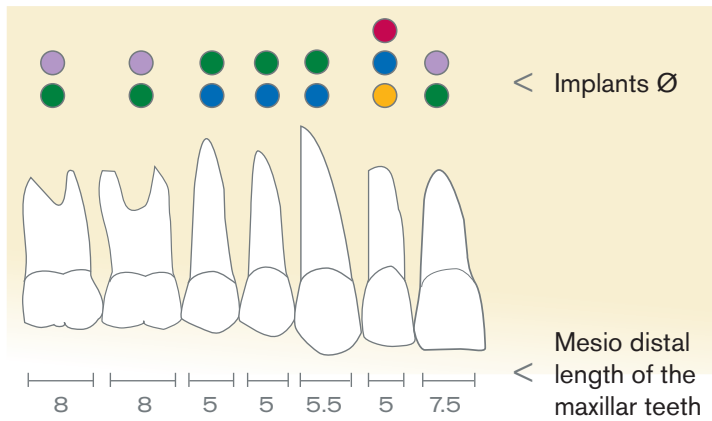

- |                                     |                 |
|-------------------------------------|-----------------|
| ● Implant Ø 3,5                     | ● Implant Ø 4,5 |
| ● Implant Ø 4                       | ● Implant Ø 5   |
| ● Implant Ø 3 (see specific manual) |                 |

Caption

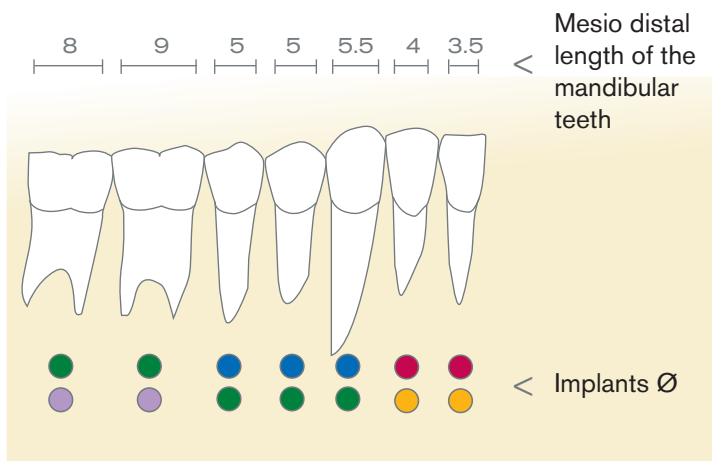

## Mandible

### Dimensions of the crown and occlusal loads

- ▶ The implant platform must be, ideally, slightly smaller than the prosthetic crown to insure the widening of the soft tissues and the prosthesis emergence. The ratio crown height/implant length must always be below 1.
- ▶ A molar replacement must be done with either 2 implants of small diameters or with an implant of large diameter so the support cusps are located in the implant's axis (better distribution of the forces on the bone).

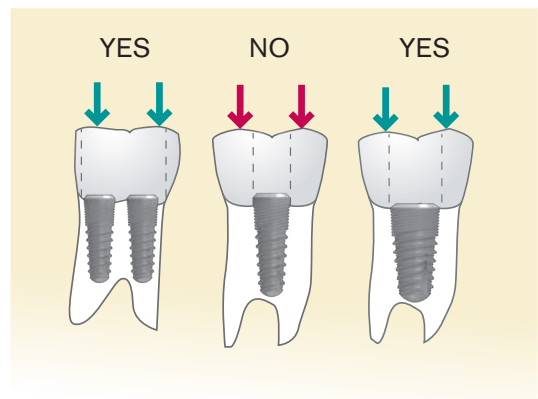

### Use of the SURGICAL TRANSPARENCIES

In order to guide the choice of the implant in terms of length and diameter, **etk** has developed surgical transparencies that show the dimensions of its different implants. Thereby, the implants are represented with 1:1, 1.3:1 and 1.7:1 magnifications (magnifications correspond to the usual magnifications of the different types of medical imaging systems: retroalveolar X-ray, X-ray dental panoramic and tomography analysis SCANORA, CBCT (Cone Beam)).

When the practitioner accurately knows the magnification of the pre-surgical X-ray, and if this magnification is 1:1, 1.3:1 or 1.7:1, by a simple superposition of the corresponding template (1:1 template for a 1:1 magnification, 1.3:1 template for a 1.3:1 magnification and 1.7:1 template for a 1.7:1 magnification), it is possible to determine which type of implant can be placed in the available bone volume.

When the practitioner does not know the magnification of the X-ray or to avoid any mistakes, he may place a reference object with known dimensions in the mouth of the patient when performing the X-ray examination in order to determine the associated magnification :

$$\text{Magnification} = \frac{\text{dimensions of the reference object measured on the radiograph}}{\text{real dimensions of the reference object}}$$

The real dimensions of the reference object shall be known to a minimum accuracy of  $\pm 15\mu\text{m}$ . The reference object shall be held in position using wax for example or by embedding the object in a partial impression. Care should be taken for the patient not to swallow the reference object. Use a safety thread if the geometry of the reference object allows it.

Then, if the calculated magnification is 1:1, 1.3:1 or 1.7:1, you may use the transparencies.

In all cases, if the magnification is not 1:1, 1.3:1 or 1.7:1, it is not possible to use the transparencies provided by the **etk** but the bone volume may be determined thanks to proportionality calculation using the X-ray and the measured magnification.

In this pre-implantation phase the practitioner must also design the coming prosthetic construction since implantology must be considered as a prosthetically driven project. Indeed, pre-prosthetic planning and surgical planning are closely linked and any change to one will have consequence on the other. It is during this phase that we may determine the number of implants, their diameters, their lengths, their locations and their orientations in order that we may proceed with the planned prosthetic construction.

# **SURGICAL PROCEDURE**

## Foreword

### Warnings

Treatment planning and placement of dental implants require specific considerations. Practitioners are recommended to take practical training in order to learn proper techniques, including biomechanical requirements and radiographic evaluation.

Improper techniques in either implant placement or restoration can result in implant failure and significant loss of surrounding bone. Drilling sequences to place implants refer to a specific depth measurement and to unique reference points for each system.

The clinician should refer to the corresponding manual to see the description of the measurement system specific to the selected product, before applying it to the patient. Every implant system has specific measurement characteristics. As a consequence, the surgeon must be familiar with the measurement system being utilized in order to be able to provide safety margins adjacent to any anatomical structure. Failure to respect these measures can result in permanent injury.

Each system has specific design characteristics. Combining non compatible components can lead to mechanical failure of components, damage to tissue or unsatisfactory results on the clinical or esthetic level.

### **For all the etk implants, the preparation of the implant site is carried out in 3 steps:**

1. Initial preparation of the implant site (marking of the bone and first drilling)
2. Calibration of the implant site (bores, drillings and/or tapping)
3. Implant placement (picking-up, screwing, stabilization and suture)



## Precautions for use

For all the surgical procedure, the following instructions must be observed and respected:

- ▶ Make sure you have a sufficient number of implants and sterile instruments
- ▶ All the instruments must be sterile, complete, checked and functional, especially the measurement instruments (calibrated according to the manufacturer's recommendation) and the cutting instruments should not be used more than 10 times.
- ▶ All the reusable products must be disinfected, cleaned and sterilized.
- ▶ All the disposable components delivered non-sterile must be disinfected, cleaned and sterilized before intra-oral use. Using a thermo-disinfector and a Class B autoclave is possible for the components out of their package, in a specific bag according to the manufacturer's recommendations.
- ▶ In case of plastic or ceramic components, always disinfect and cold sterilize with CHLORHEXIDINE.
- ▶ Any product delivered sterile (by gamma radiation) must not be re-sterilized and is for single use.
- ▶ Respect the sterile parts of the package when opening it and place its content on a sterile field.
- ▶ Respect the expiry date of the product.
- ▶ For stainless steel, the use of sodium hypochlorite is prohibited: high risk of corrosion.
- ▶ Respect the different combinations of materials when cleaning and decontaminating them in order not to damage the components.
- ▶ Detergent and disinfectant solutions must have a neutral pH or a low alkaline level.
- ▶ Any preparation of the implant site with cutting instruments on contra-angle requires profuse irrigation with a sterile saline solution (NaCl).
- ▶ Respect the sequence of the recommended instruments with a permanent control of the implant axis and depth according to the planned prosthetic restoration.
- ▶ Make sure to minimize the thermic and surgical traumatism and to eliminate any contaminant and any infection source which may cause a failed osseointegration or poor esthetic result.
- ▶ Secure the instrument and implant components handling and from the risk of fall in mouth or out of the sterile field because of their small sizes. Make sure they are properly gripped on the instruments.

# NATURALL+ IMPLANT

## Applications

**naturall+** implant is intended to treat partial or complete tooth loss on mandible or maxilla.

The implants should be placed at a bone level position, to be able to manage the best possible the prosthetic restoration with an adapted management of the biologic width and crestal edge.

## Features

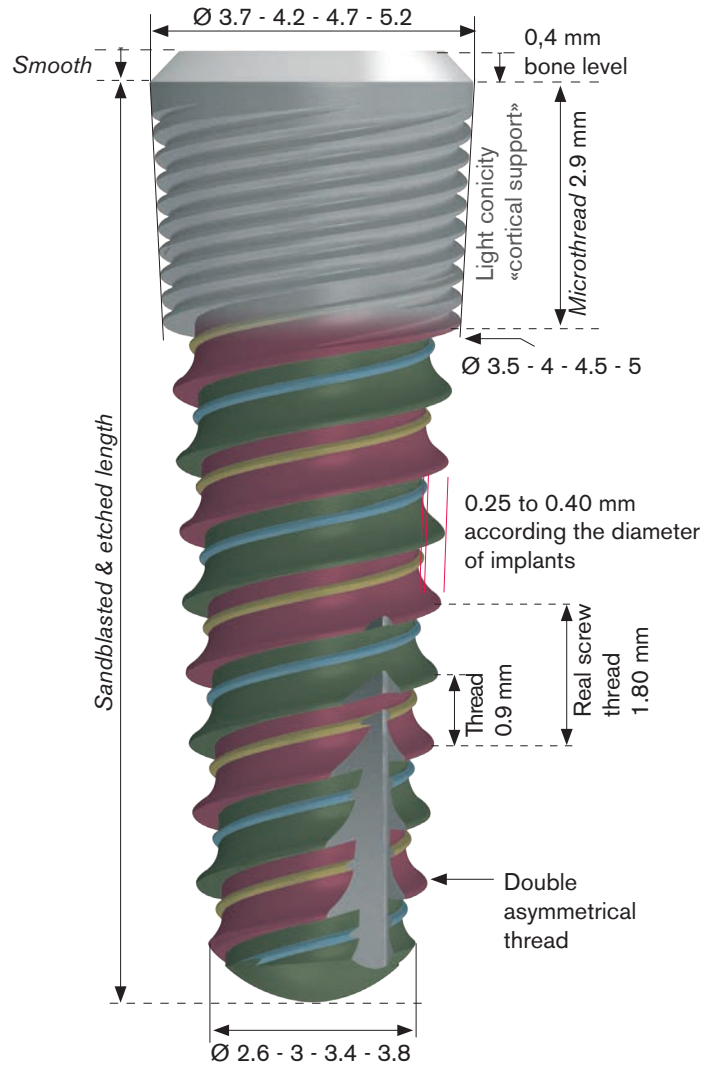

## References

Implants  $\varnothing 3,5 \rightarrow \varnothing 5$   
The implant is supplied with a cover screw.

Length	● $\varnothing 3,5$	● $\varnothing 4$	● $\varnothing 4,5$	● $\varnothing 5$
6 mm	-	-	NICP 45 060	NICP 50 060
8 mm	NICP 35 080	NICP 40 080	NICP 45 080	NICP 50 080
10 mm	NICP 35 100	NICP 40 100	NICP 45 100	NICP 50 100
12 mm	NICP 35 120	NICP 40 120	NICP 45 120	NICP 50 120
14 mm	NICP 35 140	NICP 40 140	NICP 45 140	NICP 50 140

### Direct implant driver

- ▶ Time saving during surgery.
- ▶ The insertion level and the connection orientation are easier to see.
- ▶ Informs about gingival height.



### Naturactis and Natea+ compatibility

The internal hexagonal connection of **Naturall+** implants is compatible with the Naturactis and Natea+ implants to offer a full range of prosthetic flexibility.

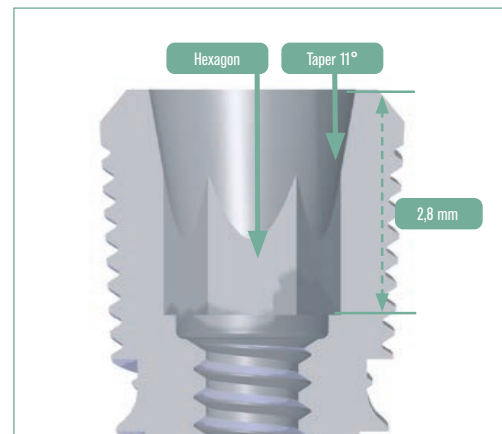

### Airtightness & stability

The internal conical connection guarantees the airtightness and the stability of the abutment-fixture connection (S.Dibart, M. Washington, M. Fan Su, Z. Skobe).

The connection has an internal hexagon which allows the abutment to be orientated at the right angle.

The depth of the connection (2.8 mm) and the quality of the joint between the parts guarantee a great stability while putting the pieces together and prevent the prosthetic from unscrewing.

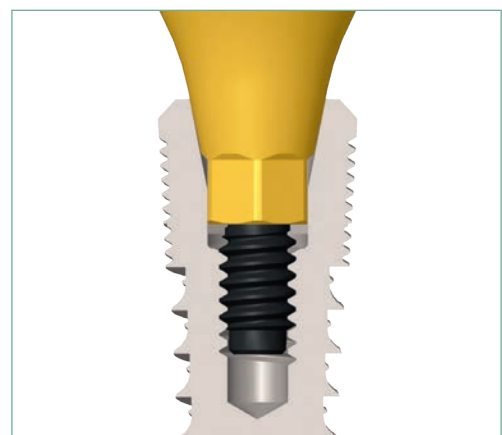

## Emergence switching

The assembled implant-abutment is not linear in profile, but has a concavity coronal to the fixture head as the abutment is narrower than the external diameter of the implant. This allows for the development of a ring of connective tissue that brings :

- ▶ **Mechanical stability of soft tissue**
- ▶ Protection of the **biological seal** by reducing the risk of trauma to the soft tissue
- ▶ The concavity **formed by the prosthetic junction isolates any inflammatory tissue**. The 3mm of biological space needed to isolate & protect the crestal bone from the external environment is achieved by the greater length (A) of the prosthetic junction concavity rather than just the height (B).

The concavity formed by the implant abutment prosthetic junction isolates any inflammatory tissue from the bone crest (see Fig 2). Richard J. Lazzara, Stephan S. Porter (PDR, volume 26 n°1, 2006)

Fig. 1 Assembly type "Platform switching"

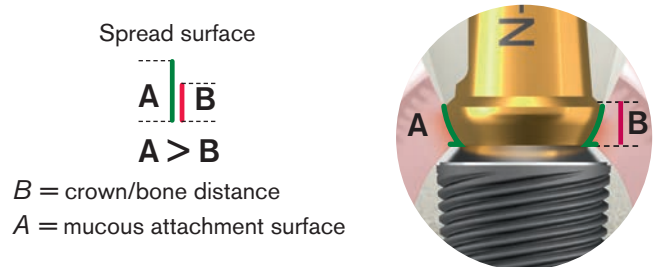
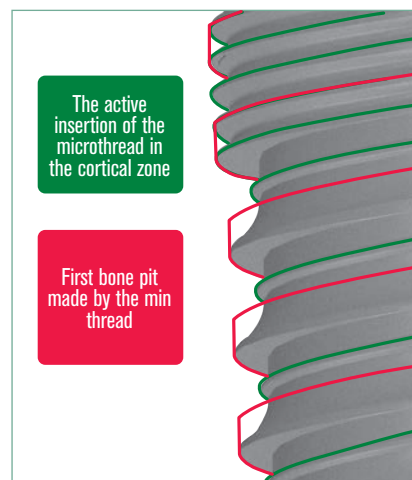

Fig. 2



## Exclusive microthread

- ▶ **Mechanical anchorage** to enhance the implant stability in critical sites made up of the endo-bone neck that suffers most of masticatory forces.
- ▶ A thicker microthread **for a higher resistance** to tear constraints.
- ▶ Synchronicity with the main thread in order not to wrest bone when following it.
- ▶ A **unique design with 6 entries** to guarantee the microthread anchorage in a precise, calibrated, similar and undamaged track.
- ▶ **Continuity with the microthreads, the protrusions and macrothreads** for a better load distribution along the implant.



**A tapered neck for a guaranteed primary stability with a cortical support**

- ▶ Implant stabilization notwithstanding a poor bone apical density.
- ▶ Control of the implant insertion for a guaranteed primary stability.

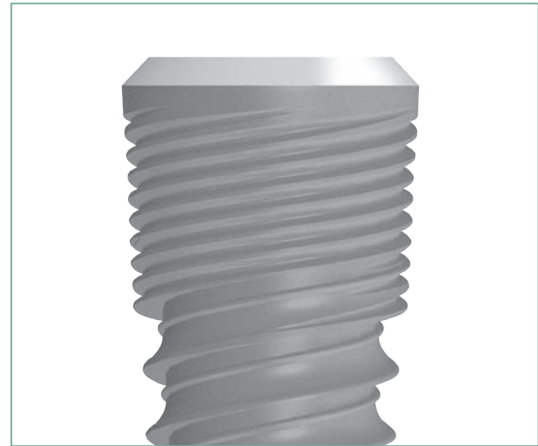

**Tapered body implant**

- ▶ Condenses bone laterally in order to increase the implant's primary stability.

**Double threads**

- ▶ Fast screwing of the implant.
- ▶ Reduced bone heating when screwing the implant.

**A central protrusion between threads**

- ▶ Increases surface contact with bone to enhance osseointegration. Cellular reconstruction is activated by this change of geometry.

**An asymmetric thread**

- ▶ The thread directly influences effective surface of the implant (B.I.C).
- ▶ Allows a better occlusal load distribution.

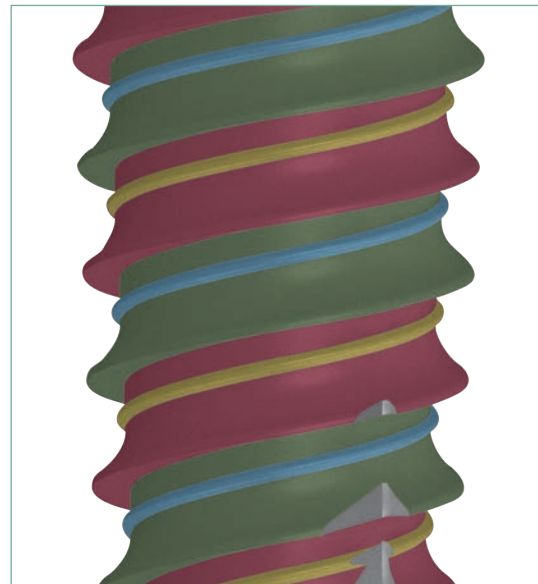

**Non traumatic and active apex**

- ▶ A groove closer to the apex to enhance the self-tapping effect of the threads.
- ▶ The threads start from the apex for a high self-tapping ability of the implant and a better apical anchorage.
- ▶ A safe use in risky sites (sinus, dental nerve...).



# SURGICAL KITS

The stake for the realization of the implant socket is on three levels:

- ▶ A calibration of the socket to obtain a good primary stability of the implant, main condition for the osteointegration.
- ▶ **Minimum overheating** to avoid all irreversible bone necrosis. The socket preparation will be made under constant external irrigation with sodium chloride at 0.9%.
- ▶ The obtainment of a calibrated socket assuring a good imperviousness.
- ▶ The instruments are sorted by their stage of use as shown by a marked on the kit. Numbers notify the main steps of each stage.

## BE CAREFUL

*It's necessary to choose the prosthetic parts before the implant placement in order to place the implant in the correct vertical position.*

## WARNING

*Beyond the quality of the irrigation, it's also appropriate to use drills for which the cutting power has not been altered by an excessive number of use. An easy way to control this is to count the number of use of each drill thanks to the tracking sheet about the drill wear (maximum 10 uses). Knowing that it exists an important variation of the wear in base of the type of bone.*

## Mini surgical KIT

Ref. NICKP\_35.4X

This new simplified kit includes all the instruments necessary to place Naturall+ implants of length's diameter from 6 to 14 mm.



### Contents:

- Point drill Ø 2.2
- Initial cylindrical drill Ø 2.2 length 14 mm
- Staged drill Ø 2.2 - 2.8 short
- Staged drill Ø 2.8 - 3.3 short
- Staged drill Ø 3.3 - 3.8 short
- Staged drill Ø 3.8 - 4.3 short
- Staged drill Ø 4.3 - 4.8 short
- Cortical drills Naturall+ Ø 3.5 / Ø 4 / Ø 4.5 / Ø 5
- Hard bone drills Naturall+ Ø 3.5 / Ø 4 / Ø 4.5 / Ø 5
- Depth gauge Ø 2.2
- Implant direct key - medium
- Implant direct mandrel - short
- External hexagonal key – length 12 mm
- External hexagonal mandrel – length 22 mm
- Mandrel extension
- Click wrench



This surgical kit offers all the instruments necessary for the realization of the surgical protocol and the management of all the bone densities for Naturactis and Naturall+ implants.

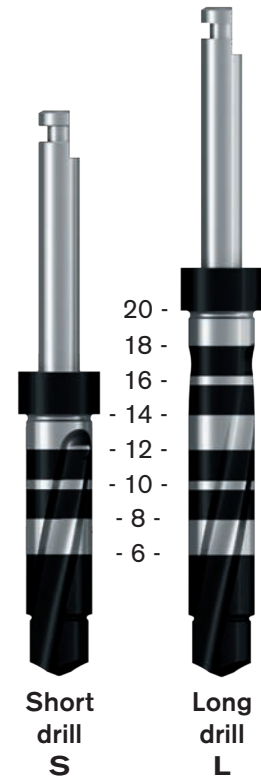

**Contents:**

- Point drills  $\varnothing$  1.5 - 2.2 and  $\varnothing$  2.2
- Initial cylindrical drills  $\varnothing$  2.2 lengths: 6, 8, 10, 12, 14, 16, 18 mm
- Depth gauge  $\varnothing$  2.2
- Staged drills  $\varnothing$  2.2 - 2.8 long & short
- Staged drills  $\varnothing$  2.8 - 3.3 long & short
- Staged drills  $\varnothing$  3.3 - 3.8 long & short
- Staged drills  $\varnothing$  3.8 - 4.3 long & short
- Staged drills  $\varnothing$  4.3 - 4.8 long & short
- Cortical drills Naturall+  $\varnothing$  3.5 /  $\varnothing$  4 /  $\varnothing$  4.5 /  $\varnothing$  5
- Hard bone drills Naturall+  $\varnothing$  3.5 /  $\varnothing$  4 /  $\varnothing$  4.5 /  $\varnothing$  5
- Taps Naturactis  $\varnothing$  3.5 /  $\varnothing$  4 /  $\varnothing$  4.5 /  $\varnothing$  5
- Paralleling pins  $\varnothing$  2.2
- Paralleling implant gauge
- Implant direct keys: short, medium & long
- Implant direct mandrels short & long
- External hexagonal keys long, medium & short
- External hexagonal mandrels short & long
- Mandrel extension
- Click wrench



Protocol BY BONE DENSITY AND IMPLANT DIAMETER

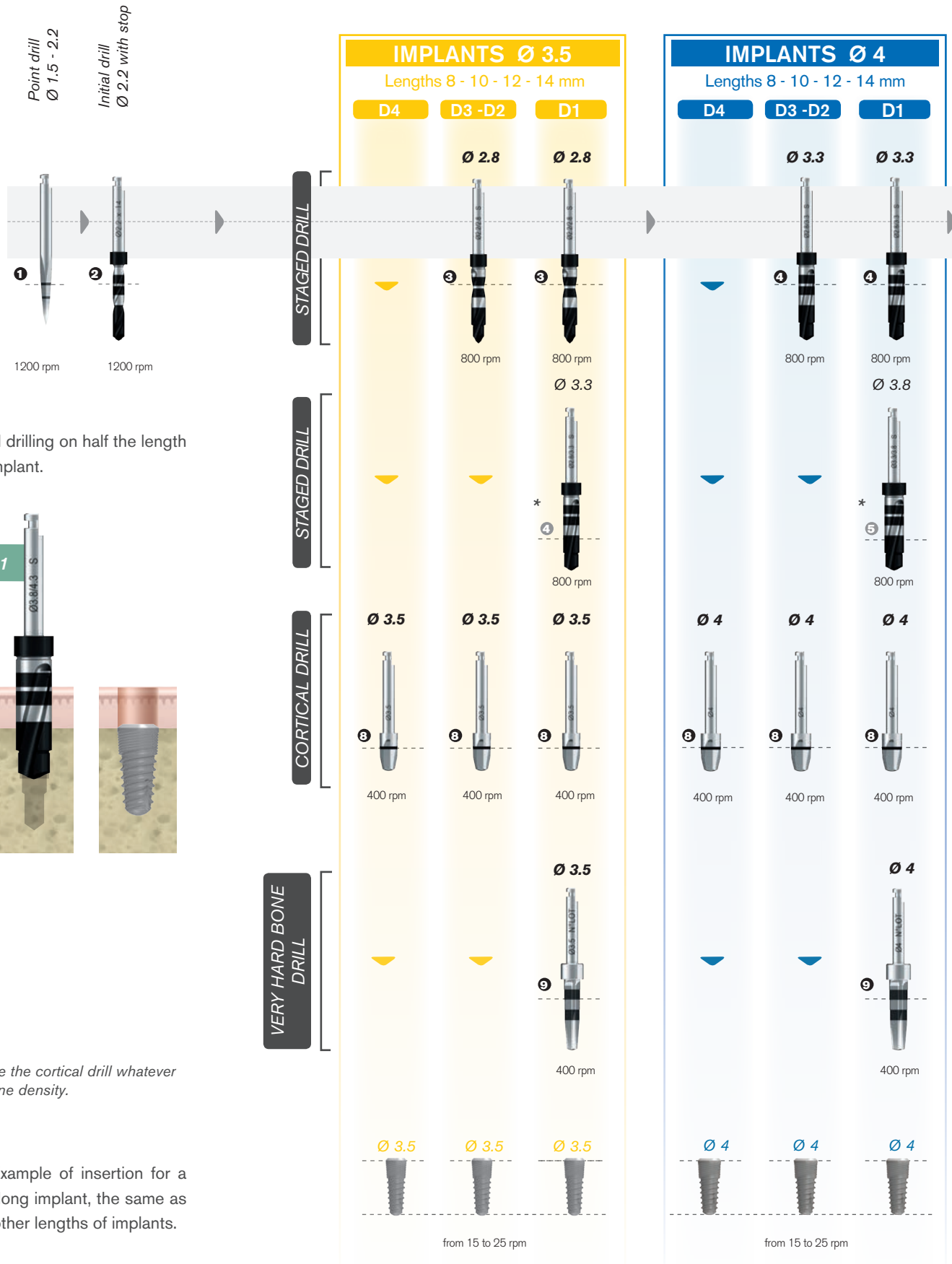





### IMPLANTS Ø 4.5

Lengths 6 - 8 - 10 - 12 - 14 mm

D4

D3 -D2

D1

Ø 3.8

Ø 3.8

5  
800 rpm

5  
800 rpm

Ø 4.3\*

\*  
6  
600 rpm

Ø 4.5

Ø 4.5

Ø 4.5

3  
400 rpm

3  
400 rpm

3  
400 rpm

Ø 4.5

9  
400 rpm

Ø 4.5

Ø 4.5

Ø 4.5

from 15 to 25 rpm

### IMPLANTS Ø 5

Lengths 6 - 8 - 10 - 12 - 14 mm

D4

D3 -D2

D1

Ø 4.3

Ø 4.3

6  
600 rpm

6  
600 rpm

Ø 4.8\*

\*  
7  
600 rpm

Ø 5

Ø 5

Ø 5

3  
400 rpm

3  
400 rpm

3  
400 rpm

Ø 5

9  
400 rpm

Ø 5

Ø 5

Ø 5

from 15 to 25 rpm

**Protocol BY BONE DENSITY AND IMPLANT DIAMETER**

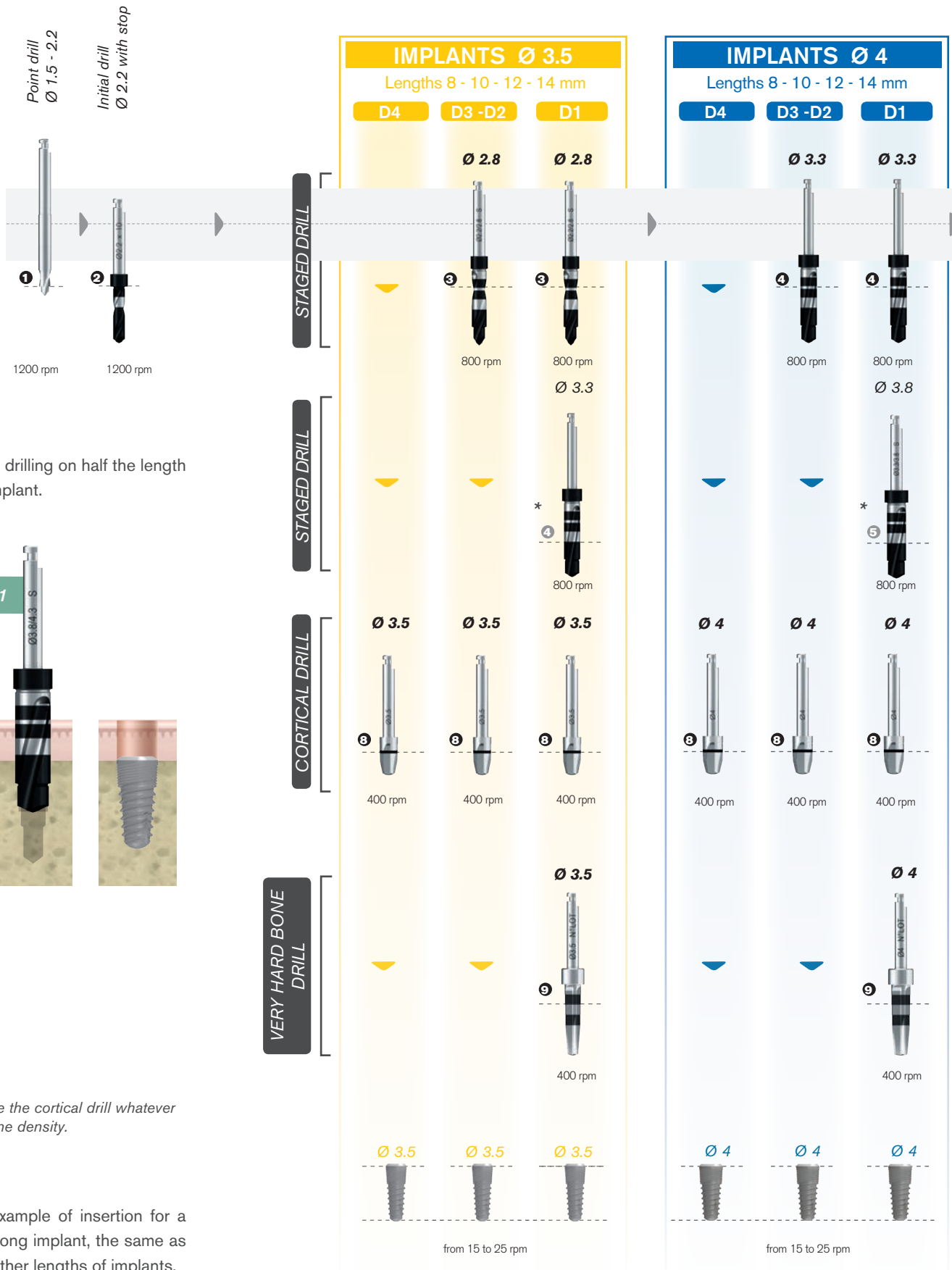







Use the cortical drill whatever is the bone density.

----- Example of insertion for a 10 mm long implant, the same as for the other lengths of implants.









### IMPLANTS Ø 4.5

Lengths 6 - 8 - 10 - 12 - 14 mm

D4	D3 -D2	D1
	Ø 3.8	Ø 3.8
▼	5  800 rpm	5  800 rpm
		Ø 4.3*
▼	▼	* 6  600 rpm
Ø 4.5	Ø 4.5	Ø 4.5
8  400 rpm	8  400 rpm	8  400 rpm
		Ø 4.5
▼	▼	9  400 rpm
Ø 4.5	Ø 4.5	Ø 4.5
from 15 to 25 rpm		

### IMPLANTS Ø 5

Lengths 6 - 8 - 10 - 12 - 14 mm

D4	D3 -D2	D1
	Ø 4.3	Ø 4.3
▼	6  600 rpm	6  600 rpm
		Ø 4.8*
▼	▼	* 7  600 rpm
Ø 5	Ø 5	Ø 5
8  400 rpm	8  400 rpm	8  400 rpm
		Ø 5
▼	▼	9  400 rpm
Ø 5	Ø 5	Ø 5
from 15 to 25 rpm		

# Surgical PROCEDURE

## Protocol STEP BY STEP

### 1 Preparation of the implant site

Prepare the access to implant site via a crestal incision through the attached gingival tissue and raise a partial thickness flap. The flap should extend to allow for proper visualization of the site and adjacent tooth root when required. A partial thickness flap is made at the proposed implant site. The reflection on the flap is made large enough to visualize the adjacent roots and not into the papilla areas in an effort to preserve this tissue. In the edentulous area, the incision is made at the crest of the ridge and reflected for access. If minimally attached gingiva is an issue, avoid over reflection of the tissues into the sulcus to preserve the attachment. The crestal incision is often made towards palate for aesthetic reasons or when the quantity of the attached vestibular gingiva is not enough. For post-extraction cases, prepare the socket in the usual way with a meticulous curettage.

### 2 Marking OF THE BONE

Set the motor speed at 1000 to 1200 RPM according to the bone quality and start irrigation. Visually pinpoint the implant areas.

The bone marking is made with a pointing drill of 1.5 mm diameter, more effective than a round bur. The pilot drill has a point which can easily go through the cortical layer. Its upper part, with a 2.2 mm diameter, is used as a guide for the following drill.

After being used, place the drill in a steel container with a saline solution.

**In case of multiple implants in the same area, proceed with the marking of sockets following the spacing rules described above.**

For post-extraction cases, prepare the socket in the usual way with a meticulous curettage.

In extraction sockets, preferably use the pilot drill to create a starting point in the palatal wall that is thicker than the vestibular bone for single-root socket, or in the bone septum of larger alveolar. The first laser marking indicates a 6 mm depth and the 2nd an 8 mm depth, and corresponds to a 2,2 mm Ø.

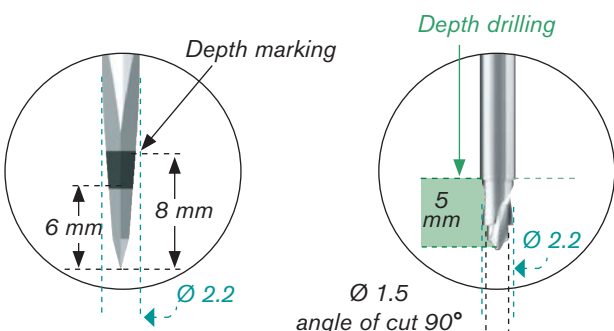

### BE CAREFUL

Maintain a minimum space around the implants according to the common rules in implantology.

- ▶ In the labio-lingual / or palatal direction save 1.5 mm to 2 mm of bone.
- ▶ In the mesio-distal plan, save 2 mm between a natural tooth & the implant thread, or 3 mm between 2 implants threads.
- ▶ The width of the implant neck must be taken into account for the implant placement. Our gauges show the neck width to help place the implants with precision.
- ▶ To anticipate the necessary space between the necks of implants:

Ø implant	● 3.5	● 4	● 4.5	● 5
Ø neck	3.7	4.2	4.7	5.2

- ▶ The Ø 4,5 shoulder of paralleling pins enable to preview spacing between the implants and thus to place the adjacent implants by leaving enough space between them.

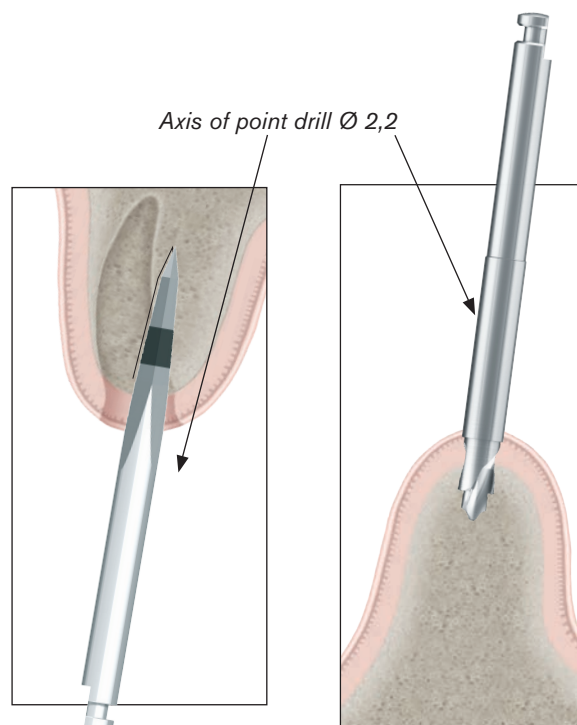

### 3 First DRILL

#### Choice of the length of the Ø 2,2 mm drill

The preparatory drill allows to determine the axis and the depth of the implant socket.

The naturall+ Ø 2,2 drills are drills with a stop. There are 5 lengths: 6 - 8 - 10 - 12 - 14 mm.

Achieve the drilling under constant external irrigation of sodium chloride, and at a speed between 1000 and 1200 rpm, according to the bone quality. The drill progression must be done without strain. If it is not the case, it indicates that bone residue are clogging the drill. An easy backward and forward motion, very controlled so as to not ovalize the area, will enable more fluid progression of the drill. This does not require a reversing of the motor if it is done at the right time. If the drill is blocked, it can be removed by using the motor reverse mode.

#### BE CAREFUL

*The rounded end of the implant doesn't fit until the very bottom of the socket prepared with the drill. The socket will be slightly deeper than the implant length. This avoids any risk of apical compression and warranties the crestal anchorage in cortical area.*

*Remember to make the axial correction at this stage if it is necessary. Thanks to the point drill previously used, the drill diameter 2.2 will be perfectly centered and guided at the entrance of the socket.*

Ø 2.2 drill of the length of the implant to be placed

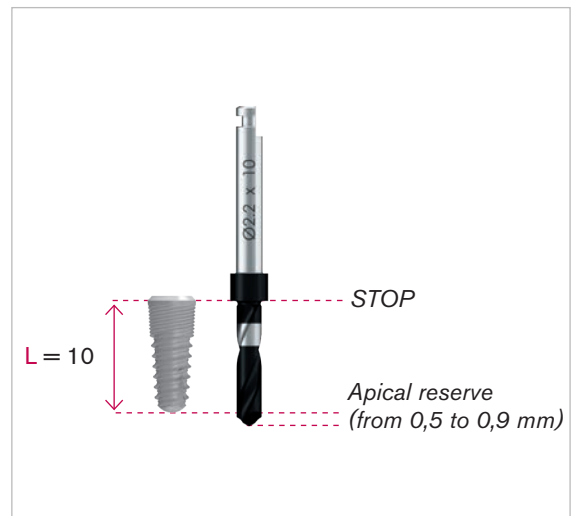
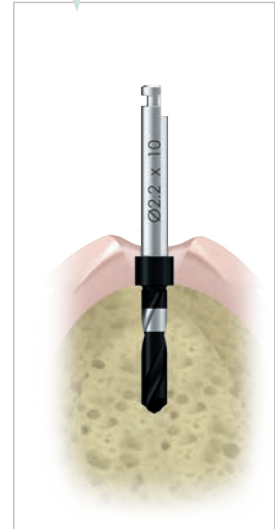

## Surgical PROCEDURE

### Protocol STEP BY STEP

#### 4 Control OF DEPTH (option)

Check the depth of the socket using the graduated depth gauge diameter 2.2 (in option - sold separately). The so placed depth gauge can also allow to control an hemorrhagic flow.

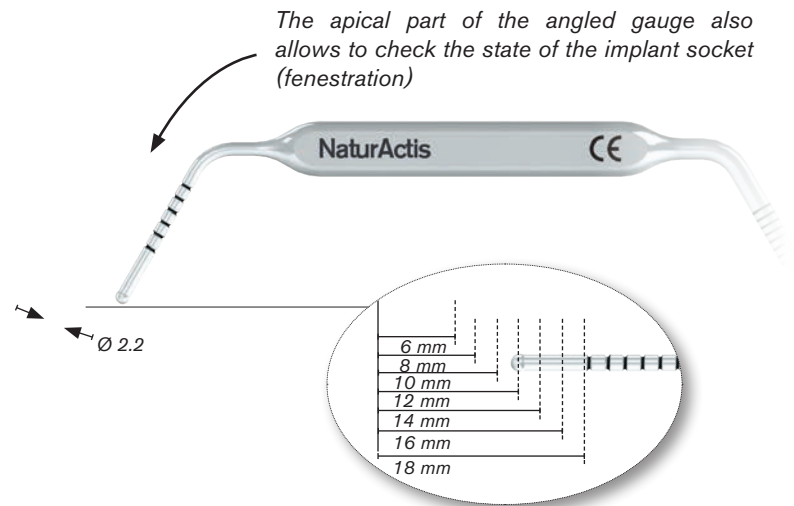

#### 5 Control of the SOCKETS AXIS

Insert the thinner side Ø 1,5 / 2,2 of the parallelism gauge(s) in the implant(s) socket(s) to evaluate the axis of emergence of the implant(s). The gauge so positioned can also control a hemorrhagic flow.

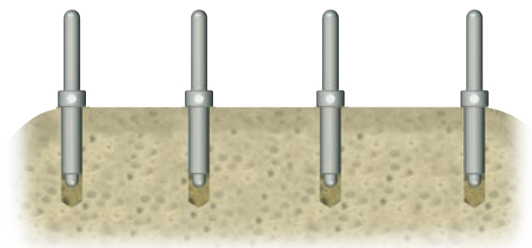

#### 6 Bone COLLECT

We advise you to collect the bone fragments resulting from each drilling in order to be able to correct any bone defect, or to improve margins of an irregular crest. The volume of the collected bone is, in most cases, enough to correct some moderate defects.

It avoids a transplant/graft and will not even require to be stabilized if the bone defect has several walls. Be careful, this bone must be preserved of any contamination and treated under the same conditions of asepsis as the implant.

#### 7 Intermediate DRILLINGS

Use the diagrams p. 24 and 25 to determine the succession of the drills corresponding to the diameter of the chosen implant, and to adapt the implant socket to the bone quality of the area. During the drillings,

verify that the bone bleeds. Should the opposite occur, scratch a little the bone to make it bleed. In the absence of vascularization, it's better to close and to wait for a revascularization.

## 8 Following DRILLINGS

Use the diagrams p. 24 and 25 to determine the succession of the drills corresponding to the diameter of the chosen implant, and to adapt the implant socket to the bone quality of the area.

During the drillings, verify that the bone bleeds. Should the opposite occur, scratch a little the bone to make it bleed. In the absence of vascularization, it's better to close and to wait for a revascularization.

**8.a** For D3/D2 bone density, continue to prepare the site with the Ø 2,2/2,8 step drill to the corresponding implant length (speed: 800 rpm). Check the drilling depth with the Ø 2,2 depth gauge.

**8.b** For D1 bone only:

Prepare the implant socket using the Ø 2,8/3,3 staged drill at a depth reduced compared with the implant length (speed: 800 rpm).

Finalize the site preparation using the Ø 3.5 hard bone drill at the implant length (400 rpm).

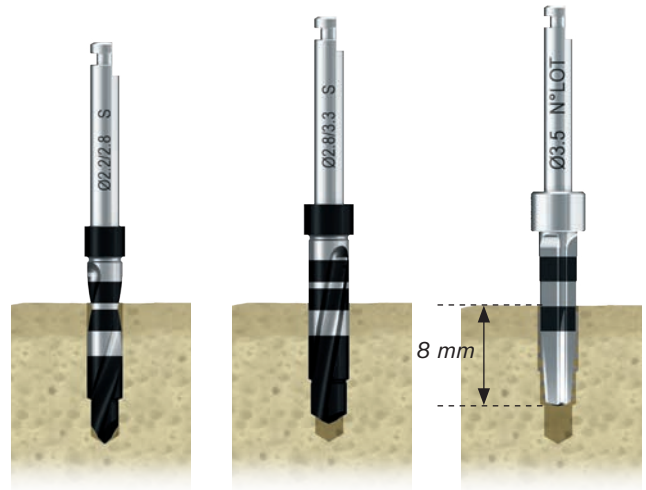

### 8.b Cortical drilling

There is 1 cortical drill for each implant diameter.

#### BE CAREFUL

*This step is required in all cases, whatever the hardness of the bone is in order to guarantee the cortical support in compression of the implant neck.*

 *Exceptionally in the case of very spongy bone you can choose to use or not an osteotome (decision of the expert).*

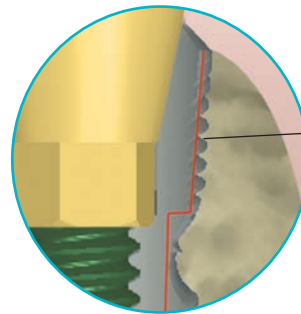
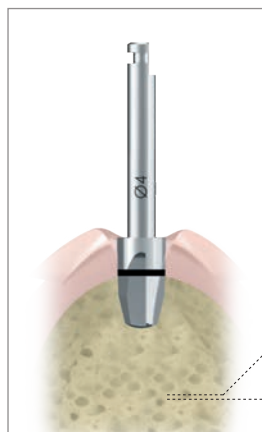

*Implant socket achieved with the cortical drill*

#### New

*Laser marking of 0.5 mm allows to manage the burying of the implant with an enhanced marking of 0.5 mm.*

 *Use the cortical drill by setting the motor speed from 300 to 400 rpm maximum and with the maximum torque.*



## Surgical PROCEDURE

### Protocol STEP BY STEP

#### 10 Implant INSERTION

The implant can be inserted manually or with the handpiece. This procedure must be done with the greatest care so that the implant does not come in contact with any non-sterile element before insertion in the bone socket. To do so, use the screwing mandrel or manual key. After opening the tube, connect the appropriate implant driver directly to the implant without taking it out of its casing before.

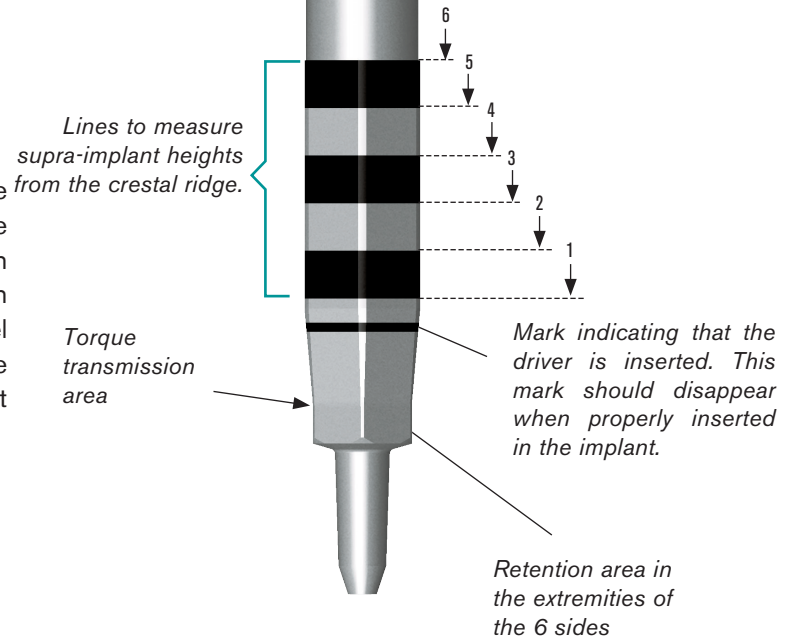

#### 10.a The implant should be taken out of its casing as follow:

*Step 1 - Seat the hexagon of the mandrel or key into the implant hexagon.*

*Step 2 - To seize the implant, slightly rotate the mandrel or key in the implant, in clockwise direction, until the implant stops turning in its casing (a device in the casing allows to limit the implant rotation while grasping it).*

*Step 3 - Insert the mandrel into the implant by applying light pressure so that it is retentive on the implant (5N= 500g).*

- The positioning marking is not visible any more, the mandrel is correctly seated.*
- The positioning marking is visible, the mandrel is not oriented nor inserted properly. In that case, go back to step 1*
- The positioning marking on the mandrel is visible, the mandrel is not oriented nor inserted properly. In that case, go back to step 2.*

*Step 4 - The mandrel is properly seated in the implant, apply light pressure counter-clockwise.*

*Step 5 - Take the implant to its receiving site.*

*Note: Be careful with the risk of fall on the floor or in the mouth when taking the implant.*

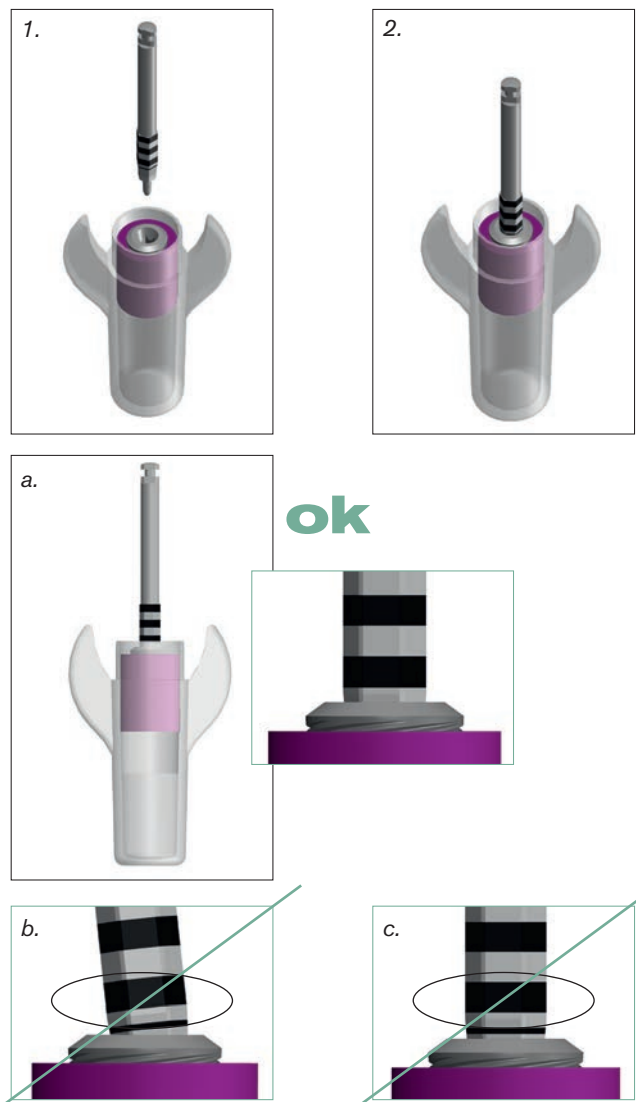



**10.b For a good positioning with the handpiece,** we recommend a speed of 15 to 25 r/mn to control the insertion of the implant. The positioning with the handpiece enables to measure the insertion torque of the implant and to evaluate its primary stability. We recommend to set the implant at 30 N.cm minimum for a delayed loading, and higher than 40 N.cm for early or immediate loading. Never exceed an insertion torque of 70 N.cm.



### **Bone D1 - D2**

For D1-D2 bone, it is recommended (during the screwing of an implant with a contra-angle), to finalize the screwing with the torque wrench, in order to ensure the good insertion of the implant.

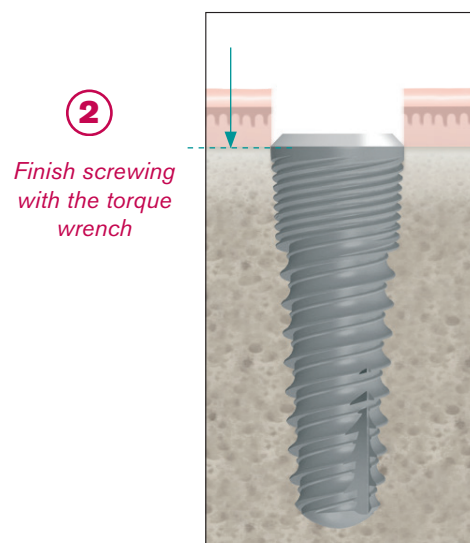
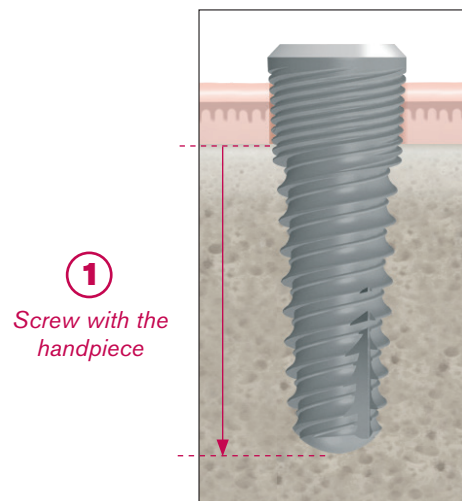

## Surgical PROCEDURE

### Protocol STEP BY STEP

**10.c In the case of manual placement,** the first screwing of the implant is achieved with the implant-holder key.

It is finalized with the click wrench or with the torque wrench. It is recommended to check the primary stability of the implant at the end of the screwing by trying to move it.

If the implant can move, its primary stability is inadequate and the osseointegration may fail; then it is better to remove it and to use an implant with a bigger diameter if the bone volume is sufficient.

#### 10.d Final implant placement

- For optimized aesthetic results, place the implant at bone level. Use the depth sign on the key or the mandrel.

The angled gauge (in option - sold separately) and the paralleling pins can also allow to measure supra-implant height.

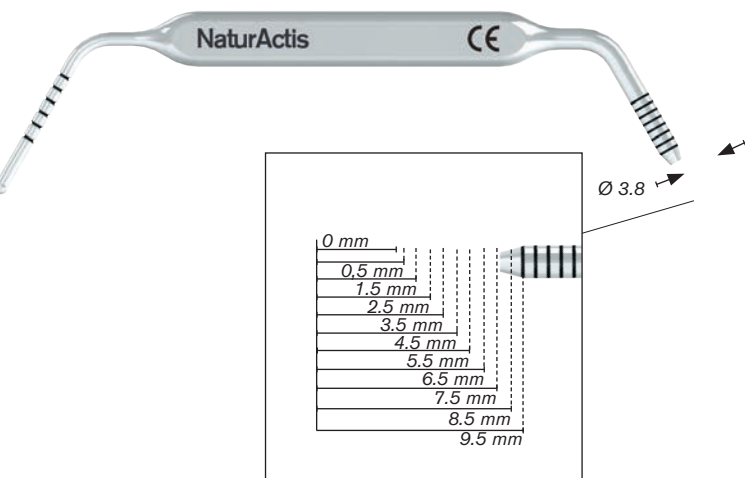

- When placing the implant, align one of the hex sides on the implant manual driver or mandrel parallel to the buccal wall, which ensures that one of the flat side of the hexagon is parallel to the buccal side, ensuring preferred prosthetic abutment orientation.

#### 10.e Removal of the driver

- To remove the driver, slightly rotate it counter-clockwise before lifting it up.



*Do not apply excessive pressure during implant placement. Excessive overtightening may damage internal connection and over-compress the surrounding bone, compromising osseointegration. If strong resistance is encountered during tightening, lightly unscrew the implant then insert back the implant. If there is still strong resistance, remove the implant and place it back into its titanium casing, and widen the implant site according to the drilling protocol.*

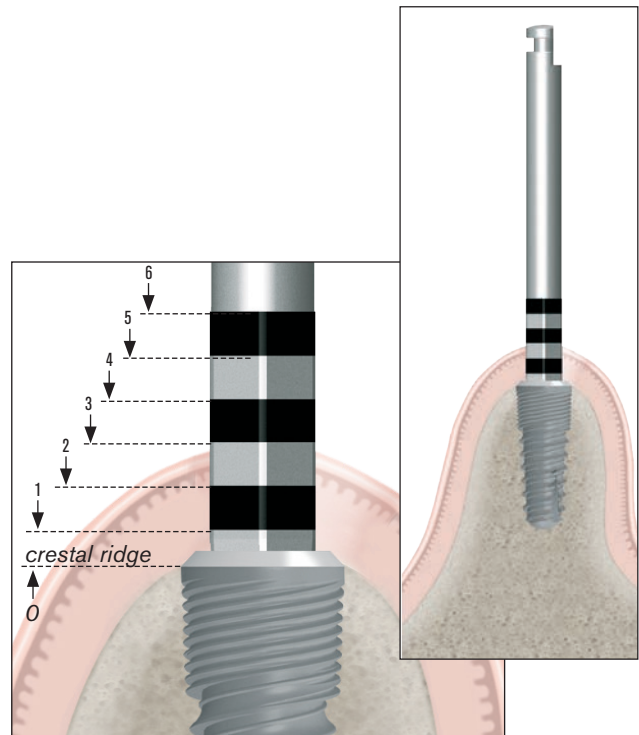

**VESTIBULAR FLAT SIDE**

## 11 Protection OF THE CONNECTION

It is ensured:

► **Either with a cover screw if the treatment includes a second surgical stage:**

It is supplied in the cap of the implant tube, and can be taken with the hexagonal key. The best way to pick it up is to turn the cap around the key (rather than actioning the key). In this case, the suture is made over the cover screw. It is recommended not to pull too much on the soft tissues to avoid any exposition of the screw.

Interrupted suture can be made every 2 mm, they should be socket tightened. If the patient has a provisional prosthesis, it is recommended to groove the intrados and rebase the denture with

a soft resin. If the patient must carry a prosthesis (in the anterior area), it should be rebased with a soft resin.

► **Either with a healing abutment if only one surgical stage is planned:**

Select the most relevant part to get an aesthetic and natural shape of the soft tissues around the implant.

Screw manually the abutment with the external hexagonal key at 10 N.cm or with the torque wrench (ref. CCC35) for a better precision.

## 12 Osseointegration

The conventional period to obtain a good osseointegration is:

- 3 months at the mandibular,
- 6 months at the maxillary due to a different bone quality.

The dentist should define this period by taking into account the bone quality, the implant primary stability and the prosthetic plan.

In certain cases, the dentist can decide to connect the prosthetic parts without waiting for the osseointegration.

However, the dentist must be able to analyze if the conditions of the clinical case are appropriate to an immediate loading.

Studies and scientific datas indicate that immediate loading has proven to be successful at the mandibular when the prosthesis is built on 4 implants or more linked together. Immediate loading is not recommended on a single implant.

### In case of failure

To extract an implant, try to unscrew it with the implant driver or the implant direct key. If this solution is insufficient, please refer to the note of the **etk** extraction kit.

The socket can possibly be re-implanted\*:

- if the patient is ready to receive a new implant,
- with an implant of wider diameter, in the case that the placement of this implant occurs at the same time.

To put another implant with a smaller diameter, it is better to wait for the complete healing of the socket.\*\*

\* It is important that the reasons of the failure are analyzed before placing a new implant.

\*\* The doctor decides whether it is necessary to use bone material to fill in the socket.



EXTRACTION KIT

KDR 3N

# HEALING PROCESS

## In case the implant has been placed without being immediately loaded THE SOCKET IS RE-OPENED 3 TO 6 MONTHS LATER

- ▶ Use a probe to locate the cover screw.
- ▶ Open the site with a gingival punch if there is sufficient attached gingiva on both sides of the crest.
- ▶ If necessary repel the bone that has been growing on the cover screws with small enamel chisel or a small bone trepan.
- ▶ Unscrew the cover screw with an hexagonal key or mandrel (reverse mode at low speed).
- ▶ Clean the top of the implant surface and rinse with physiological serum.
- ▶ Measure the depth of gingival sleeve by introducing a probe through the gingival tissue to the base of the smooth cone, which is loaded on top of the implant.
- ▶ Choose a healing abutment according to the prosthetic plan.

### Choice of THE HEALING ABUTMENT

The healing abutment allows to give its shape to the future emergence prosthetic profile while waiting for the stabilization of the gingival height.

- ▶ In order to select the most appropriate healing abutment, the burying depth of the prosthetic joint and the desired emergence profile have to be defined first.

**A** & **B** enable to determine the most appropriate abutment. The table below shows you the healing abutment corresponding.

- ▶ The neck depends on the aesthetic emergence profile that you want to achieve; the prosthetic abutment should have the same conicity. This must be a sufficient angle to have embrasures for the passage of tooth brush. It must also achieve a specified distance between contact points of crowns and the summit of the interdental bone crest (Prof. Tarnow); this distance must be lower than or equal to 5 mm. The angle defined by the conicity must exert a light pressure on the papilla to stimulate the healing without risk of necrosis.

- ▶ Healing abutments have a higher diameter (0,4 mm) than the final abutment:
  - to avoid gingiva stick and improve patient's comfort,
  - to make the intervention faster,
  - for easier and less painful insertion of impression copings and definitive abutments (avoid anesthesia).

1. Final prosthetic project to be achieved

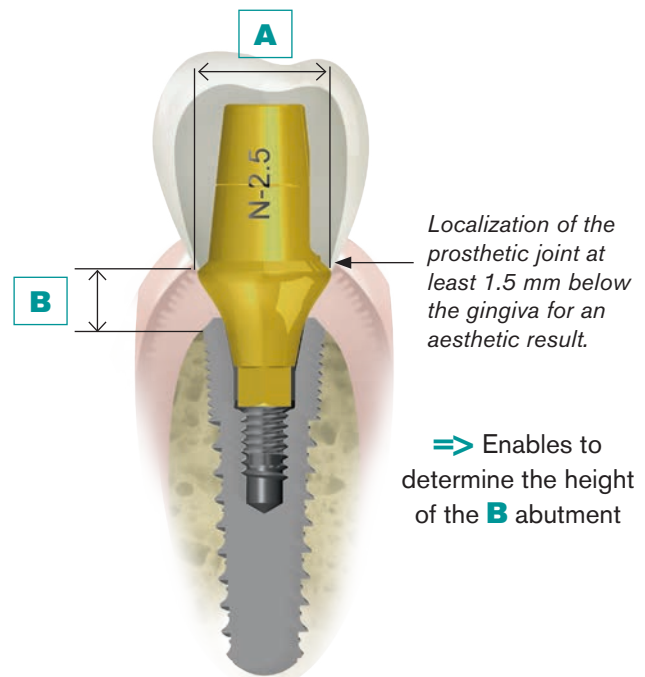

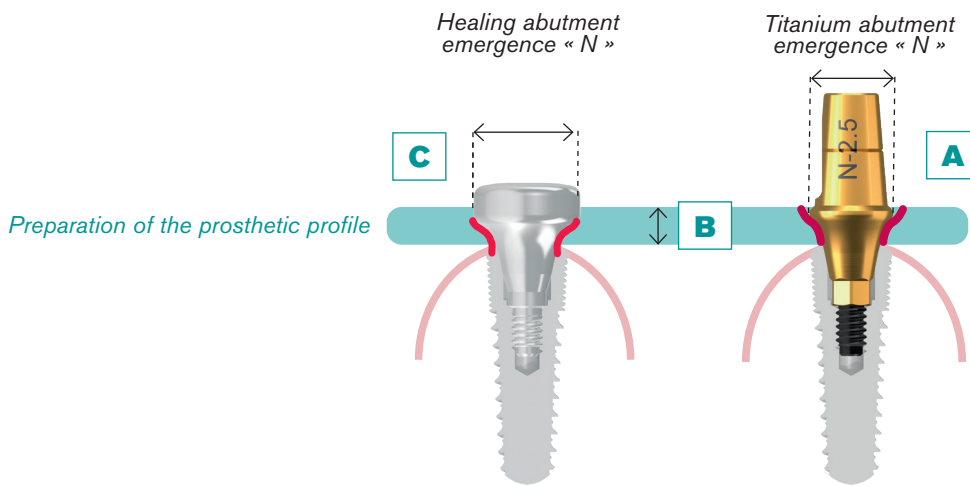

### Table for the selection of the tissue-level parts emergence

Use a healing abutment which has a same emergence profile than the titanium abutment which will be placed later.  
Tighten the healing abutment at 10 N.cm with the external hexagonal key.

► Laser code on the top of the abutment

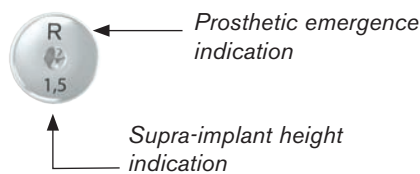

Platform letter	Emergence diameter
E (Extra narrow)	Ø 3.6
N (Narrow)	Ø 4.6
R (Regular)	Ø 5.2
W (Wide)	Ø 6

Prosthetic profile	Ø C	Healing abutments (prepare gingival profile)	Ø A	Titanium abutment with a corresponding emergence profile	Supra-implant height
	3.8	NCI 36 23	3.6	NPS PD 36 06	0.5
		NCI 36 34		NPS PD 36 16	1.5
		NCI 36 45		NPS PD 36 26	2.5
		NCI 36 56		NPS PD 36 36	3.5
		NCI 36 67		NPS PD 36 46	4.5
	5.0	NCI 46 23	4.6	NPS PD 46 06	0.5
		NCI 46 34		NPS PD 46 16	1.5
		NCI 46 45		NPS PD 46 26	2.5
		NCI 46 56		NPS PD 46 36	3.5
		NCI 46 67		NPS PD 46 46	4.5
	5.6	NCI 52 23	5.2	NPS PD 52 06	0.5
		NCI 52 34		NPS PD 52 16	1.5
		NCI 52 45		NPS PD 52 26	2.5
		NCI 52 56		NPS PD 52 36	3.5
		NCI 52 67		NPS PD 52 46	4.5
	6.4	NCI 60 34	6.0	NPS PD 60 16	1.5
		NCI 60 45		NPS PD 60 26	2.5
		NCI 60 56		NPS PD 60 36	3.5
		NCI 60 67		NPS PD 60 46	4.5



# IMPRESSION TECHNIQUES

## Impression TECHNIQUES

Depending on the clinical case, you can choose to make impressions using 3 different techniques:

### Technique WITH PICK-UP IMPRESSION COPING

#### Material required



#### External hexagonal keys

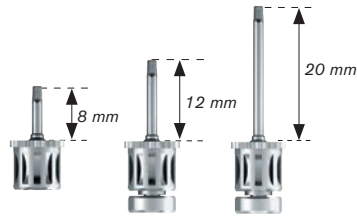

short  
CCL HE 12 18  
medium  
CCL HE 12 22  
long  
CCL HE 12 30

#### Pick-up impression copings

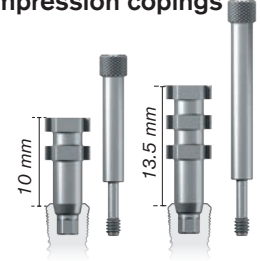

short  
NPE T35  
long  
NPE T35 L

#### Implant analog

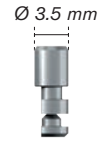

NLA H35

#### External hexagonal mandrels



short  
CMA HE 12 22

long  
CMA HE 12 26

### Technique WITH POP-IN IMPRESSION COPING

#### Material required



#### External hexagonal keys

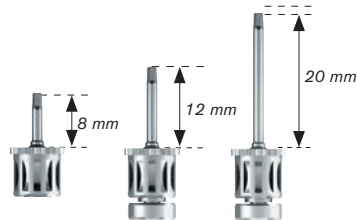

short  
CCL HE 12 18  
medium  
CCL HE 12 22  
long  
CCL HE 12 30

#### Pop-in impression coping

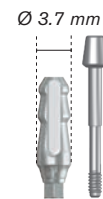

NPI 37

#### Implant analog

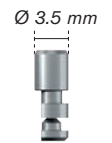

NLA H35

#### External hexagonal mandrels



short  
CMA HE 12 22

long  
CMA HE 12 26

### Technique WITH POP-UP IMPRESSION COPING

#### Material required

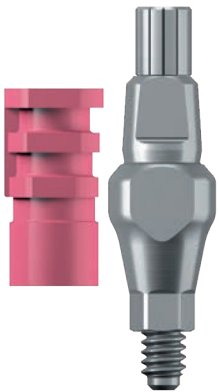

#### External hexagonal keys

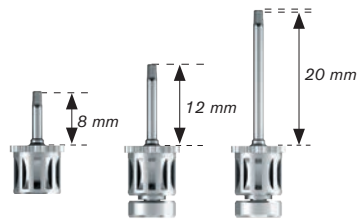

short  
CCL HE 12 18  
medium  
CCL HE 12 22  
long  
CCL HE 12 30

#### Pop-up impression coping

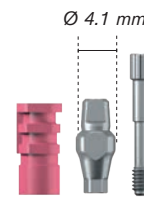

NPU 35

#### Implant analog

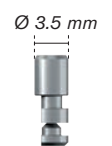

NLA H35

#### External hexagonal mandrels



short  
CMA HE 12 22

long  
CMA HE 12 26



## 1 Technique with PICK-UP IMPRESSION COPING

### PROTOCOL

- ▶ After having unscrewed the healing abutment, manually screw the pick-up transfer into the implant using the hexagonal key. Do not exceed the 10 N.cm maximum tightening torque.
- ▶ You can choose between 2 heights of impression coping according to your case:
  - Short: height 10 mm
  - Long: height 13,5 mm
- ▶ After making sure the transfer is positioned correctly, make the impression using an open tray and clear the head of the screw.
- ▶ Once the impression has been made, unscrew the pick-up transfer using the external hexagonal key.
- ▶ Remove the impression.
- ▶ Screw the analog onto the transfer.
- ▶ Be careful to always hold the analog and not the tray.

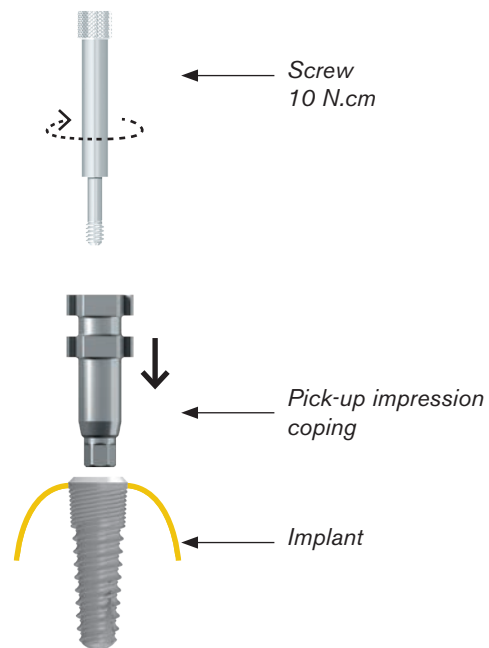

### Important Information

#### Advantages

- ▶ Precision
- ▶ Better accommodates divergent axes
- ▶ Repositioning errors are impossible (except analog)
- ▶ Ideal for multiple and single cases

#### Disadvantages

- ▶ Long unscrewing time with the tray in place in the mouth = uncomfortable for patients with problems swallowing and vomiting
- ▶ Lengthier implementation, with the removal of the splint heads and of the impression material
- ▶ Restricted oral aperture contra-indicated on implantation sites in the posterior sections

## 2 Technique with POP-IN IMPRESSION COPING

### PROTOCOL

- ▶ After having unscrewed the healing abutment, manually screw the pop-in transfer into the implant using the external hexagonal key. Do not exceed the 10 N.cm maximum tightening torque.
- ▶ After making sure the transfer is positioned correctly, make the impression with a closed tray.
- ▶ Remove then the impression, ideally in the transfer axis.
- ▶ Unscrew the pop-in transfer using the external hexagonal key.
- ▶ Screw the analog onto the transfer, manually orient and re-position the transfer into the impression.

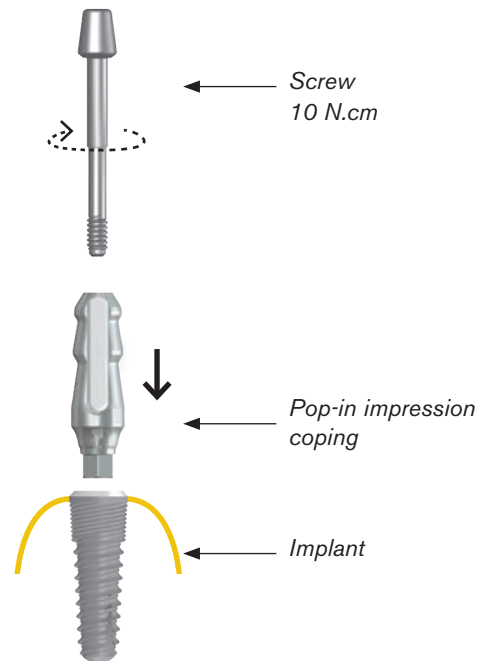

Make sure the transfer is inserted and oriented correctly into the impression.



### Important Information

#### Advantages

- ▶ Restricted oral opening
- ▶ Unscrewing after having taken out the tray = more comfortable for the patient
- ▶ Ideal for single cases

#### Disadvantages

- ▶ Precision varies depending on the quality of impression materials
- ▶ Possible repositioning errors
- ▶ The divergence between the implants should be lower than 20°
- ▶ Not recommended for multi-unit cases

### 3 Technique with POP-UP IMPRESSION COPING

#### PROTOCOL

- ▶ After having unscrewed the healing abutment, manually screw the pop-up transfer into the implant using the external hexagonal key. Do not exceed the 10 N.cm maximum tightening torque.
- ▶ After making sure the transfer is positioned correctly, install the clippable transfer cap.
  - Orient the pink cap rib towards the transfer's flat plane.
  - Clip: hear the insertion "click".
- ▶ Make the impression with a closed tray.
- ▶ Once the impression has been made, remove the tray, ideally on the transfer axis.
- ▶ Unscrew the pop-up transfer using the external hexagonal key.
- ▶ Screw the analog onto the transfer, then orient and reposition the transfer into the impression, clipping it into the transfer cap.

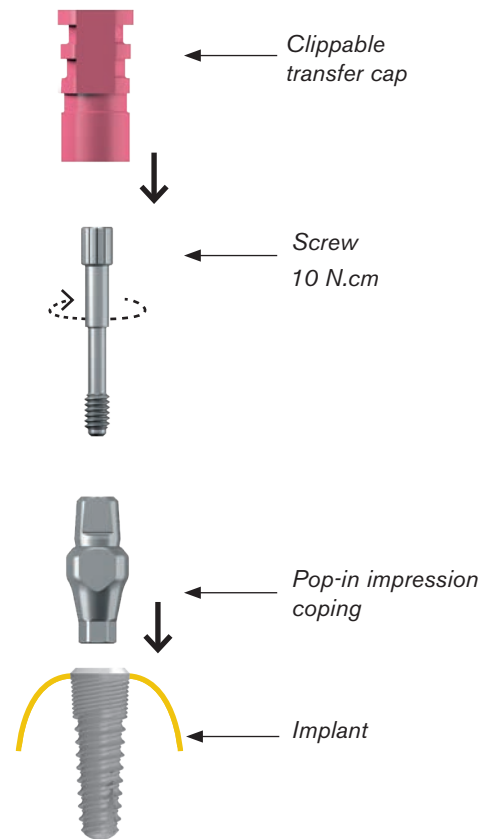

Make sure the transfer is inserted and oriented correctly into the impression cap.

**It is possible to use the pop-in version using the screw ref. NPS VTB 16 156.**

#### Important Information

##### Advantages

- ▶ Precision
- ▶ Restricted oral opening
- ▶ Unscrewing after having removed the tray = more comfortable for the patient
- ▶ Ideal for single cases

##### Disadvantages

- ▶ Possible repositioning errors
- ▶ Divergence between implants should be lower than 20°



# PROSTHETIC PROCEDURE

### Foreword

#### Warning:

- ▶ The tightening torques indicated in this manual should be respected to avoid risks of damaging, breaking or dysfunction of the items.
- ▶ Check the proper assembling of parts in order not to cause the prosthesis to fail and to guarantee its mechanical functions.
- ▶ Secure the instruments and prosthetic components handling from the risk of fall in the mouth or out of sterile field because of their small sizes. Make sure they are properly gripped on the instruments.
- ▶ Certain prosthetic components are delivered sterile to be used during the surgery. ATTENTION not to re-use them.
- ▶ All the disposable components delivered non-sterile must be disinfected, cleaned and sterilized before intra-oral use.
- ▶ Respect the decontamination and/or sterilization rules (plastic or ceramic components cannot be sterilized in an autoclave).
- ▶ In case of plastic or ceramic components, always disinfect and cold sterilize with CHLORHEXIDINE.
- ▶ Any product delivered sterile (by gamma radiation) must not be re-sterilized.
- ▶ Respect the sterile parts of the package when opening it and place the content on a sterile field.
- ▶ Respect the expiry date of the product.
- ▶ Check the proper assembling of parts in order not to cause the prosthesis to fail and to guarantee its mechanical functions and the final esthetic result.



#### **A unique common connection**

The Naturactis Naturall+ Natea+ a unique common connection for all the diameters.

# CEMENTED PROSTHESIS

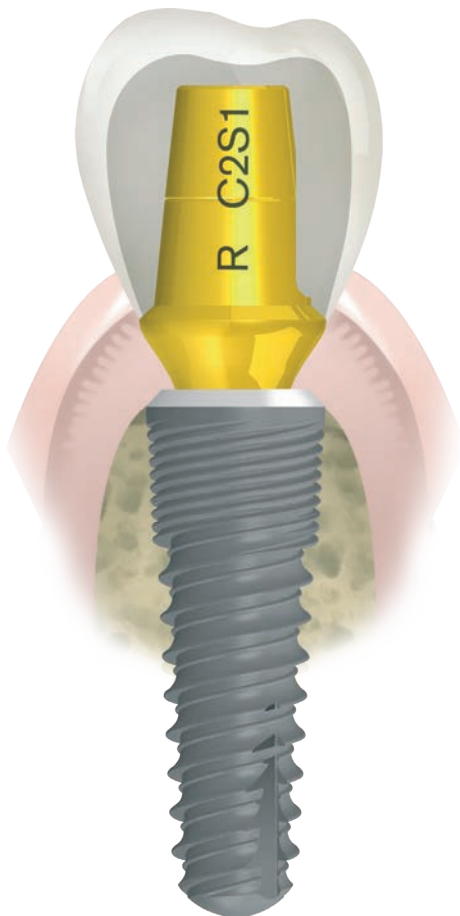

## 4 PLATFORMS



Ø 3,6



Ø 4,6



Ø 5,2



Ø 6,0

## Cemented prosthesis ON TRANS-SCREWED ABUTMENT PROTOCOL

1. After removing the healing abutment, take the impression with the impression coping into the implants.
2. Unscrew the impression coping
  - ▶ if a **pop-in** impression coping has been used, the impression may be withdrawn directly. Impression coping is then unscrewed, connected to analog, and then placed back in the impression.
  - ▶ if a **pick-up** impression coping has been used, the impression coping must be unscrewed to be removed. The analog is then connected to the pick-up impression coping inside the arch of the impression. (see picture 2).
3. Send the impression to the laboratory.
4. The plaster cast model is made at laboratory.
5. The laboratory chooses the abutment: straight or angulated (7°, 15° or 20 ° - see the prosthetic panorama). The abutments can be customised if necessary. They are placed on model with a laboratory screw. (see picture 3)
6. Make the wax-up on the abutment.
7. Cast the wax-up and finalize the crown.
8. Seat the abutment in the mouth with the abutment screw provided in the pack. Use a dynamometric key to apply the proper tightening torque. (see picture 4). If the abutment was fitted some time before, tighten to the correct torque level once again before fitting the prosthesis.
9. Take an x-ray to check the fit of the abutment in the implant.
10. Final adjustment of the finished prosthesis.
11. Cement prosthesis onto the abutment.

*\* Do not use the final abutment screw in the lab or for trying of the prosthesis; this would alter its physical properties.  
For try-ins and laboratory work use lab guide screws: ref. NPS VG 16 200, NPS VG 16 250.  
For final fixing in the mouth use a new abutment screw.*



*Use the torque wrench for the precise tightening of the prosthetic parts at 25 N.cm*



1. SCREWING THE IMPRESSION COPING

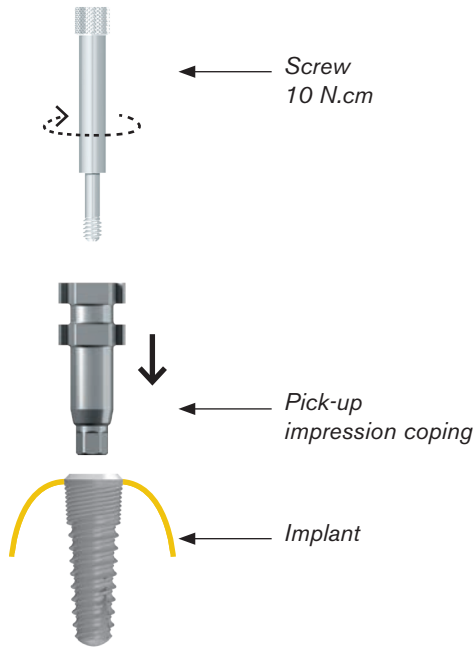

2. CONNECTING THE IMPLANT ANALOG

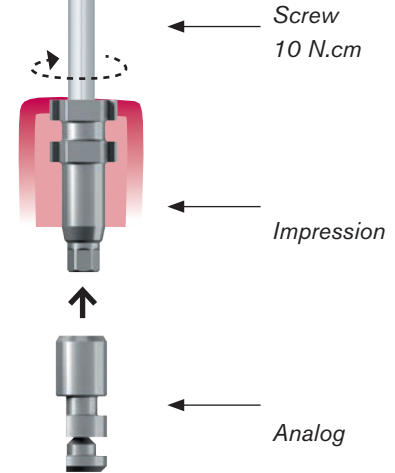

3. ON THE PLASTER CAST MODEL

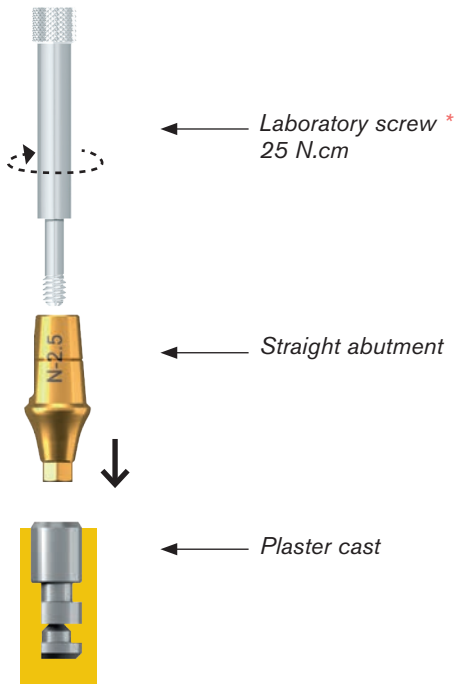

4. IN THE MOUTH

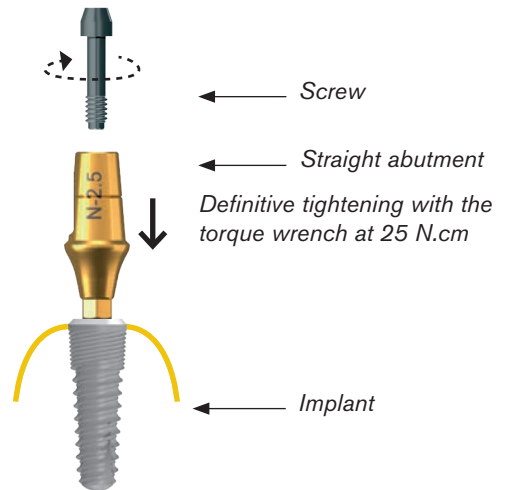



# CEMENTED PROSTHESIS ON DIRECT CLIP ABUTMENT

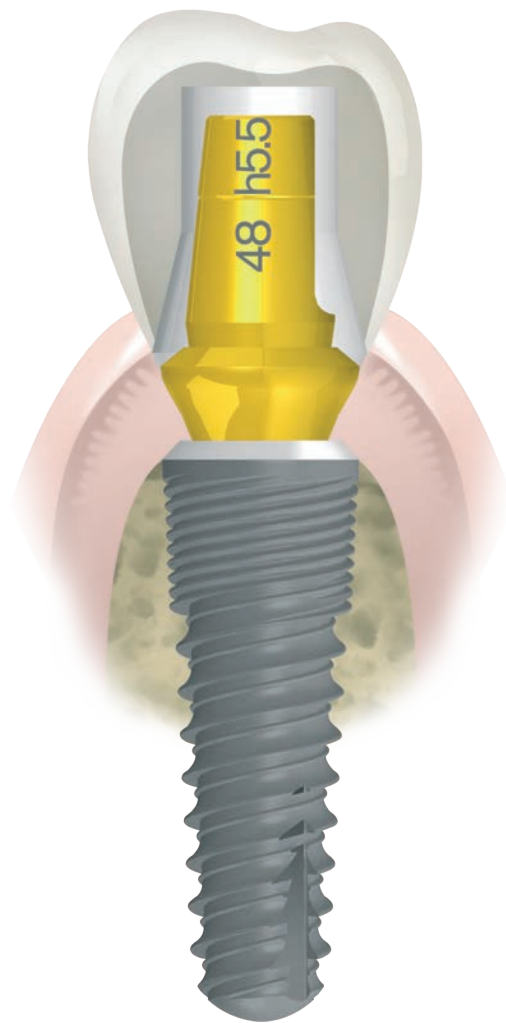



## DIRECT CLIP ABUTMENT USE

- ▶ A standard protocol using snap-fit impression copings ensures an accurate impression, which gives a reliably accurate model of the abutment.
- ▶ The impression coping snaps onto a small prominence located above the abutment shoulder (see the red area on the picture below).
- ▶ The burn-out sleeves are not snapped on the abutments in order to allow the technician to remove them more easily and to avoid reshaping which may compromise the prosthetic joint.

### Impression coping

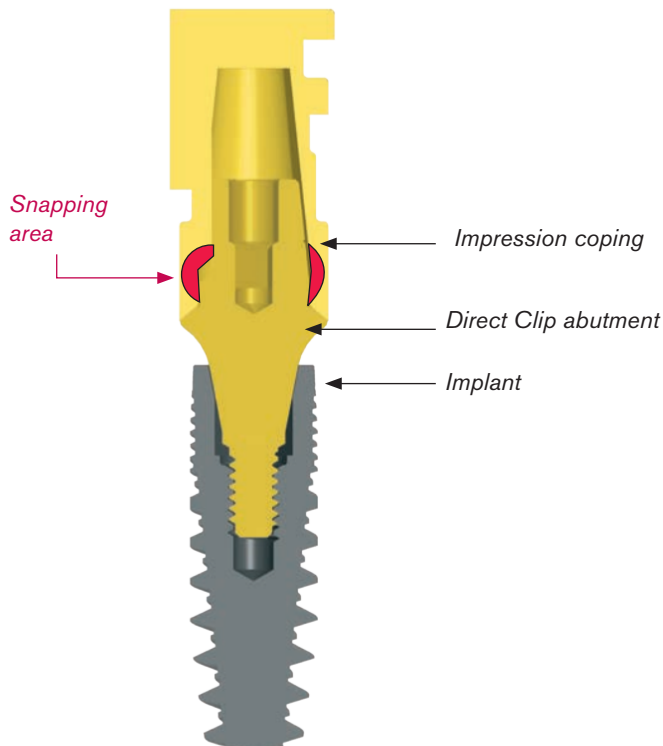
Easy to fit over the Direct Clip abutment **without clearing the sulcus.**



 Make sure to align the flat plane of the abutment with the interior flat plane of the impression coping.

**Two types of impression copings are available:**

- ▶ When restoring unshortened Direct Clip abutments, use the colored snap-on impression coping over the abutment in a closed tray.
- ▶ When the abutment has been modified, use the white open impression coping over the abutment (see page 56).

**Protocol**  
ON UNMODIFIED DIRECT CLIP ABUTMENTS

1. Choose the abutment height (4 – 5.5 – 7 mm).
2. Screw the abutment with the torque wrench (ref. CCC 35) at 35 N.cm.
3. Snap on the coping onto the abutment.  
Make sure to align the rib of the coping with the flat side of the abutment. Then, the impression material is spread all around the impression coping covering it completely. This technique gives an accurate impression of the implant shoulder (information is given by the coping part and not the impression material). (Picture 1)
4. Remove the impression and connect the abutment analog into the impression coping inside the impression. The snap fit guarantees the correct position of the analog. (Picture 2)
5. Fit the protection cap on the Direct Clip abutment. (Picture 3)

**LABORATORY STEPS**

6. Make the plaster cast model.
7. Seat the burn-out sleeve on the analog and wax up the framework. (Picture 4)
8. Cast the wax-up.
9. Make the ceramic part of the prosthesis.
10. The crown is cemented on the abutment in the mouth after the removal of the protection cap.

PICTURE 1. IMPRESSION ON UNMODIFIED DIRECT CLIP ABUTMENT

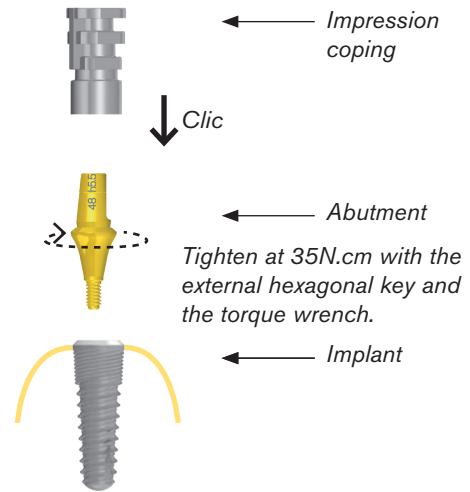

PICTURE 2. USE OF ANALOG

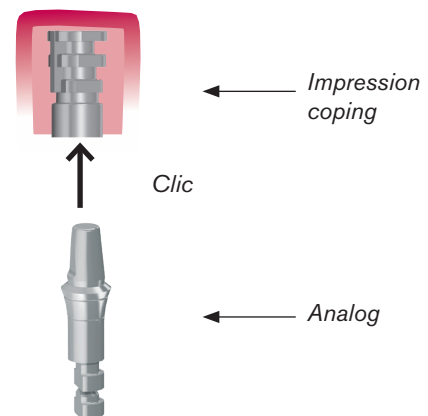

PICTURE 3. PROTECTION CAP

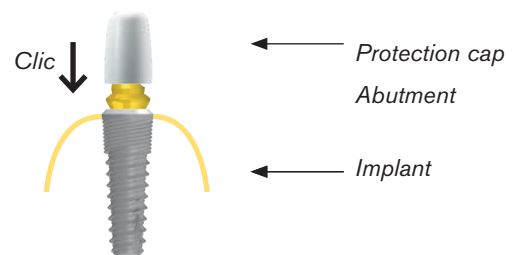

PICTURE 4. ON PLASTER CAST

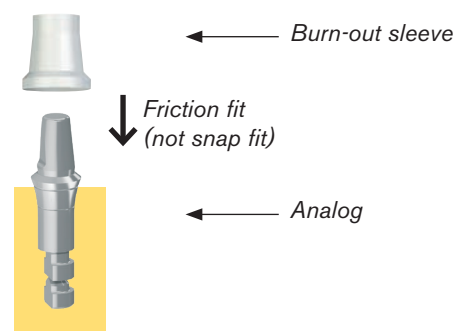

## Protocol ON MODIFIED DIRECT CLIP ABUTMENTS

Adjustments on Direct Clip abutments do not allow to fully enjoy the advantages of a standard impression system. We recommend applying the following technique only on single crowns for which the prosthetic adaptation is less sensitive to inaccuracy of impression copings.



Photo credit : Dr J. BOUCHET (France)

PICTURE 1. IMPRESSION ON MODIFIED ABUTMENT

1. Choose the abutment height (4 – 5.5 – 7 mm).
2. Adjust the Direct Clip abutment (respecting the shaping limit).
3. Place and tighten the abutment at 35 N.cm.
4. Take the impression with the white open impression coping snapped onto the abutment. Gentle pressure allows the impression coping to fit onto the abutment. Then, the impression material is injected inside and all around the impression coping until it covers completely the plastic part. (see picture 1)
5. Protection cap setting onto the abutment during the prosthesis manufacturing time.

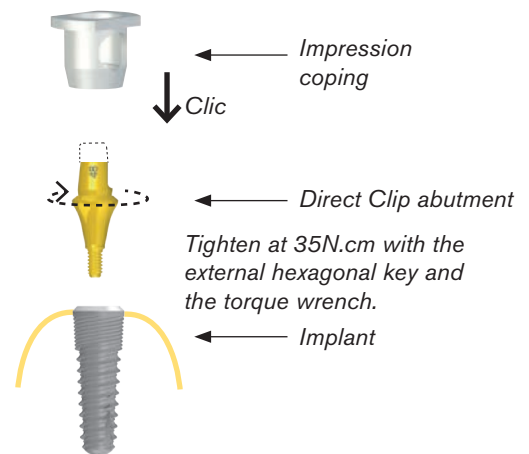

PICTURE 2. PROTECTION CAP

### LABORATORY STEPS

6. Make the model with the impression. Use epoxy resin instead of plaster.
7. Seat the burn-out sleeve on the model and wax-up of the framework.
8. Cast the wax-up. (see picture 3)
9. Make the ceramic part of the prosthesis.
10. The crown is cemented after removal of the protection cap.

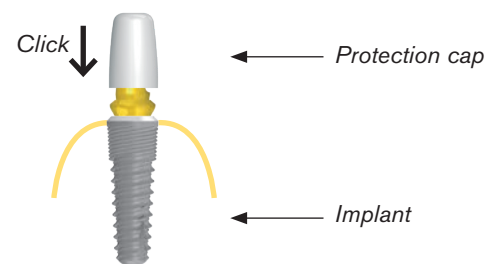

PICTURE 3. ON PLASTER CAST

### Multi-unit prosthesis

A very precise adaptation of the prosthesis is necessary to avoid any tension / fracture. That is why we recommend the use of uncut Direct Clip abutments with an adapted height (the shortest possible to tolerate the axial divergences of implants). If no abutments are suitable, it is better to work with trans-screwed abutments and to make the impression on implants.

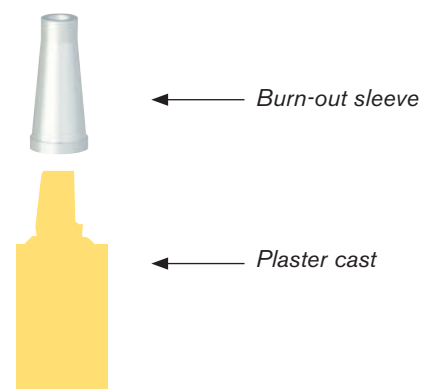

## Temporary RESTORATIONS

► A provisional restoration can be fabricated on the protection cap of the Direct Clip abutment. The protection cap will be then sealed onto the Direct Clip abutment.



1. Choose the protection cap adapted to the abutment used.
2. Make some grooves on the cap to improve the retention of the temporary tooth.
3. Put a small quantity of provisional cement inside the cap and on the Direct Clip abutment.
4. Seat the cap on the Direct Clip abutment until you feel the snap on the basis of the abutment.
5. Check the correct placement of the cap and remove excess cement.
6. Make the provisional restoration on the cap.

## Direct Clip abutment KITS

These kits include all parts necessary for a cemented restoration on the selected height of Direct Clip abutment. This avoids any error when purchasing the parts which will have to be used together: easy to identify the parts and no risk of forgetting one of the parts. This kit is supplied without direct Clip abutment.

### The kit includes:

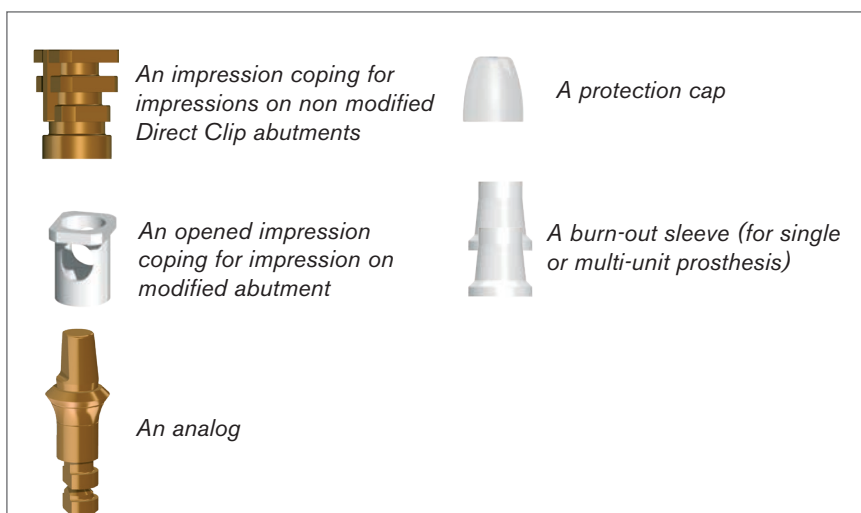





# ZIRCONIA PROSTHESIS ON ESTHETIBASE INTERFACE

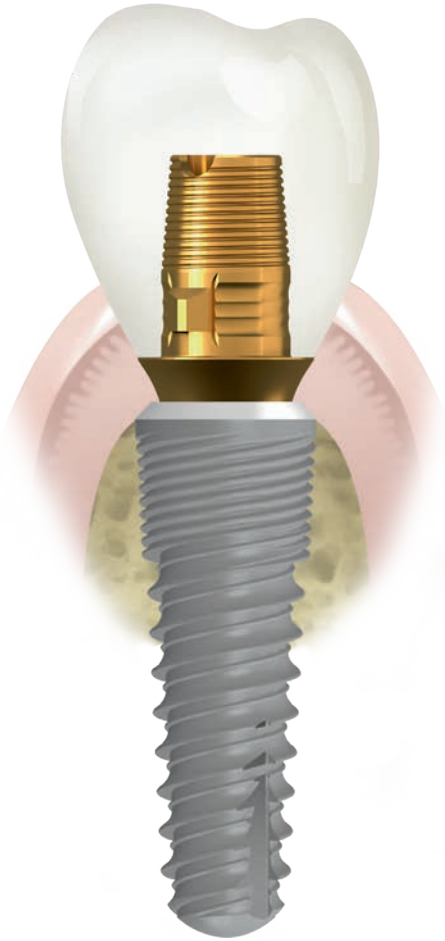

Zirconia prosthesis give an excellent aesthetic result to implant restorations. A biocompatible titanium coating on the abutment which connects with the implant ensures an excellent seal and reduces stress as the contact is titanium to titanium.

**Discreet**

**Thin titanium interface**

- ▶ Thin collar and low profile
- ▶ Invisible in the final restoration

**Even more discreet**

- ▶ Biocompatible coating of yellow titanium nitride coating
- ▶ Softer colour at the gingival margin

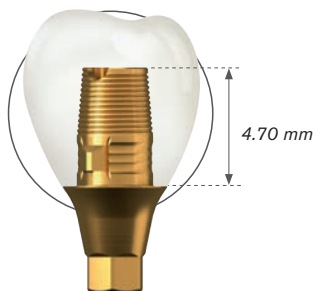

**Reliability**

**Titanium on titanium contact**

- ▶ The interface avoids a zirconia contact on titanium implant connection.
- ▶ Same hardness as the implant, there is no alteration of the connection and it maintains a good seal

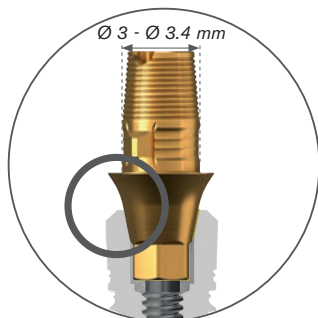

**Applications**

**Single crowns**

The thin titanium interface allows abutments or collars to be made in zirconia or pressed ceramic.



**Coping**

**Abutment**

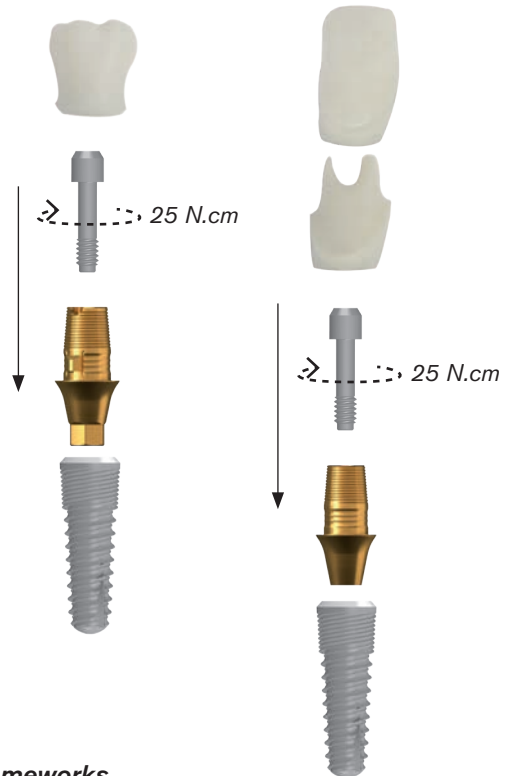

**Frameworks**



## Protocol

### 1. Production of the restoration.

- in pressed ceramic (coping): use the usual technique of lost wax
- in manufactured zirconia (abutment): the model of the manufactured element will be delivered either on traditional physical model, or in digital format (scanner or CAD).

### 2. Sandblasting of the interface.

First protect the connection and the gingival area, then sandblast the surface that will be in contact with the bonding composite with a medium grain size <50 microns under a pressure of 2 bars.

### 3. Clean the interface with ethanol.

### 4. Bonding.

Use a self-curing universal self-adhesive composite. Apply the composite on the titanium interface and the zirconia abutment or sleeve, then assemble the two parts. For a complete polymerization of the material follow the instructions of the product manufacturer.

### 5. Screw tightening.

Tighten at 25 N.cm according to the diameter of the screw. Please order lab guide screws separately, do not use the same screw for lab work and final fixing in the mouth:

Short 8 mm : **ref. CCL HE 12 18**

Medium 12 mm : **ref. CCL HE 12 22**

Long 20 mm : **ref. CCL HE 12 30**

## 1. PRODUCTION OF THE RESTORATION

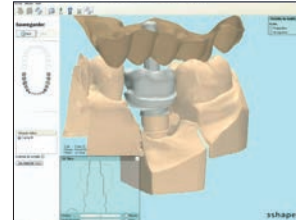

© ALFONSI Laboratory (Paris - France)

## 2. SANDBLASTING OF THE INTERFACE



© GARCZAREK Laboratory (Sallanches - France)

## 3. CLEAN THE INTERFACE WITH ETHANOL



© GARCZAREK Laboratory (Sallanches - France)



# SCREWED PROSTHESIS

## ON PLURAL ABUTMENTS

*For the prosthetic management of divergent implants  
Abutments with titanium nitride coating to improve aesthetics*

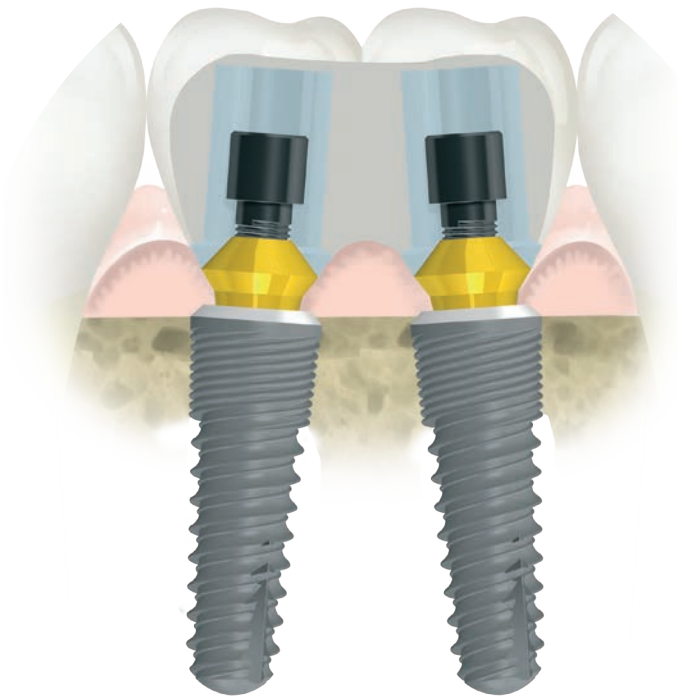

## ON TETRA ABUTMENTS

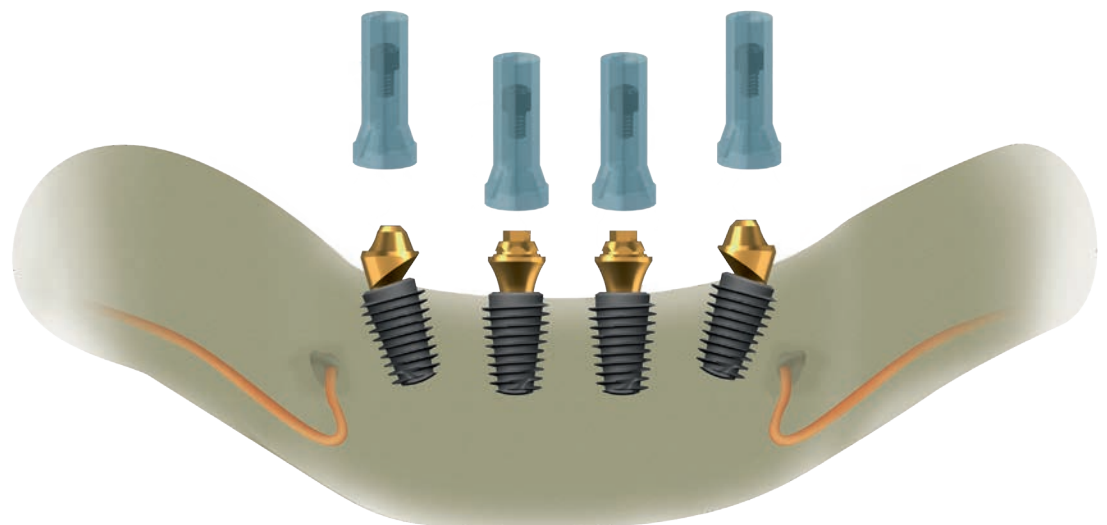

## 2 abutments types FOR THE SCREWED PROSTHESIS

### Plural:

- ▶ For multi-unit prosthesis on parallel or divergent implants.
- ▶ Small size of Ø 3.8 mm for reduced spaces and taper height of 1.8mm of the prosthetic part.
- ▶ Secondary components different for the straight and angulated versions.
- ▶ Tapered support of the bar.
- ▶ Unsuitable for single crowns.

### Tetra:

- ▶ For multi-unit prosthesis on parallel or divergent implants.
- ▶ Single crowns possible with dedicated parts.
- ▶ Common secondary parts for the straight and angulated versions with a wide choice.
- ▶ Easy grip and positioning with a rigid handle.
- ▶ Wide diameter of 4.8 mm for a good support laid flat on the neck.

## Single-unit screwed restoration ON TETRA ABUTMENT

### For single prosthesis

1. The healing abutment is removed and the straight Tetra abutment is screwed onto the implant in the mouth with the internal hexagon key (*ref. CCL HI 25 26*) and the torque wrench (*Ref. CCC 35*) at 25 N.cm
2. Screw the impression coping onto the Tetra abutment with the hexagonal key (*ref. CCL HE 12 22*). (see picture 1)
3. Take the impression.
4. Unscrew the impression coping and remove the impression. Screw the analog onto the impression coping.
5. While the prosthesis is being fabricated, the abutment can be covered with one protection cap.
6. The plaster cast model is made at laboratory.
7. Use a gold palladium abutment onto the analog on the model with a lab guide screw. (see picture 4)
8. Fabricate the prosthesis and thoroughly clear the access screw.
9. Try in the mouth, check and adjust occlusion.
10. Finish the prosthesis.
11. Final fitting of the complete prosthesis. The insertion should be passive.

12. Tighten the prosthesis on Tetra abutment to 20N.cm with the torque wrench (*Ref. CCC 35*). Seal the screw heads and access holes. (see picture 5)

### HOW TO USE GOLD PALLADIUM ABUTMENTS DIRECT CLIP TO LIQUID

Characteristics of the gold and base chemical composition:

Gold (Au)	58,25 +/- 1 %
Platinum (Pt)	21,90 +/- 1 %
Palladium (Pd)	19,41 +/- 1 %
Iridium (Ir)	0,44 +0,5 % / -0 %

Hardness (HV) > 160

Direct Clipus - Liquidus : 1400 - 1490 °C

Density: 17.5 g / cm<sup>3</sup>

Thermal Expansion : 12.4 µm / m °K



Do not use the final abutment screw in the lab or for trying of the prosthesis; this would damage the physical properties. For try-ins and laboratory work use lab guide screw ref. NPV VG 14 105. For finalfixing in the mouth use a new abutment screw.

1. SCREWING THE IMPRESSION COPING

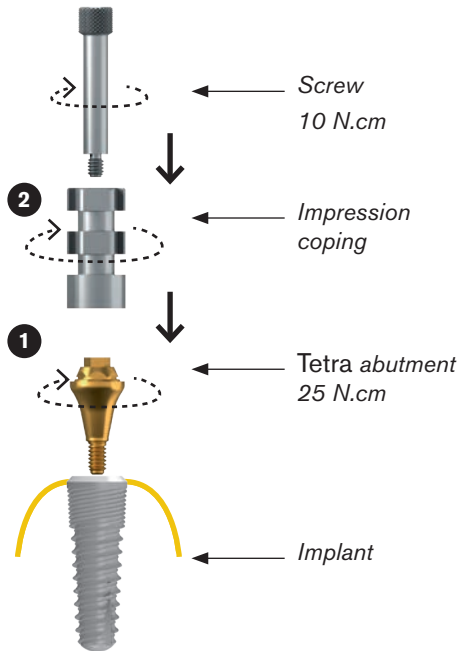

PICTURE 2. CONNECTING THE ANALOG

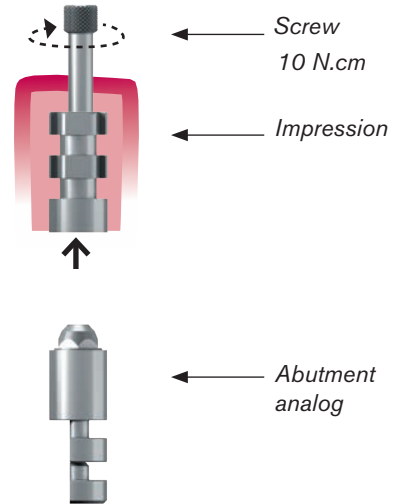

PICTURE 3. PROTECTION CAP

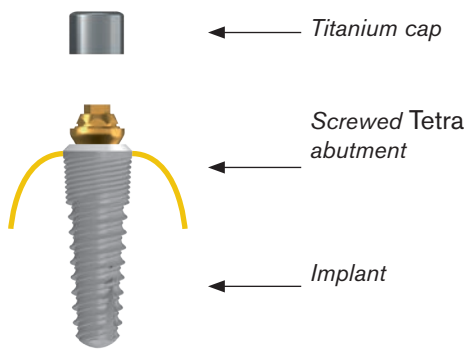

PICTURE 4. ON THE PLASTER CAST MODEL

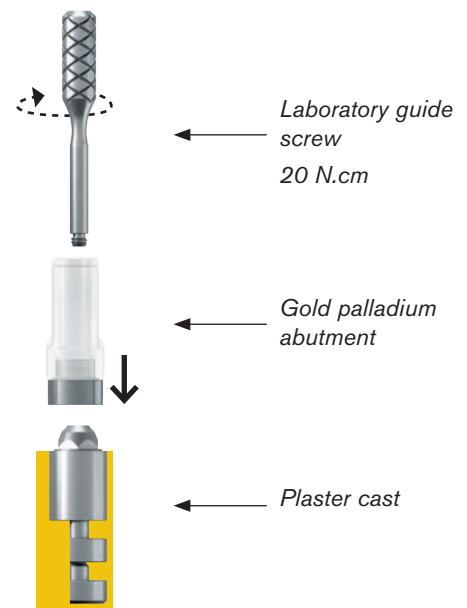

PICTURE 5. IN THE MOUTH

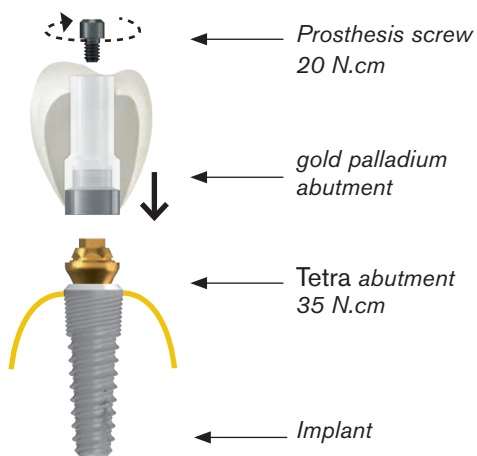

## Multi-unit screwed restorations ON TETRA ABUTMENTS

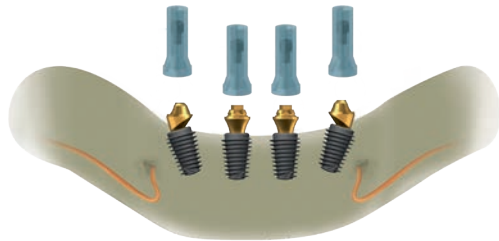

1. Remove the cover screws or the healing abutments and set up the Tetra abutments on implants in the mouth.
2. Screw the angulated abutments with the external hexagonal key at 25 N.cm and the straight abutments with the internal hexagonal key (ref. HI2024) at 35 N.cm. (see picture 1)
3. Make the impression with the pick-up technique (described in picture 2) or pop-in impression coping.
4. Screw the protection caps at 10 N.cm or the temporary abutments on Tetra abutments at 20 N.cm with the torque wrench (Ref. CCC 35). A temporary prosthesis may be realised on temporary abutments or protection caps. (see picture 3)

### LABORATORY STEP

5. Making the prosthesis using the burn-out sleeves clearing the sockets of screws access. (see picture 4)
6. Fitting of the infrastructure in the mouth. The insertion must be passive. Checking and adjustment of occlusion.
7. Final adjustment of the prosthesis.

8. Tightening of the prosthesis on the Tetra abutments in the mouth with the torque wrench (Ref. CCC 35) at 20 N.cm. Seal the screw heads and access holes.



Use a new screw for the final tightening.  
For your fittings, use other screws especially reserved for that purpose.  
For laboratory manipulations, use guide screws.

PICTURE 1

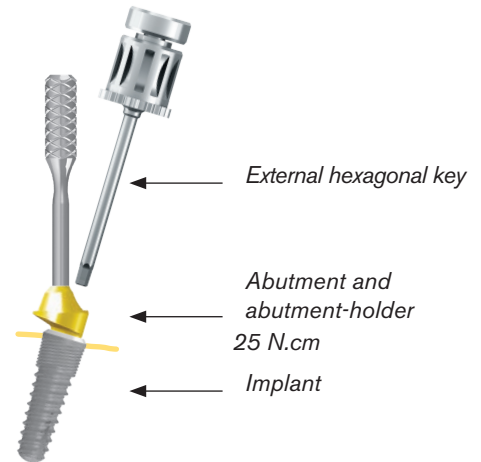

PICTURE 2

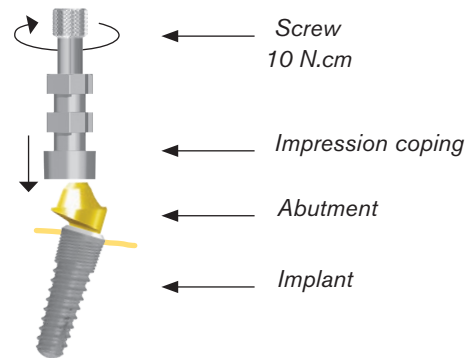

PICTURE 3

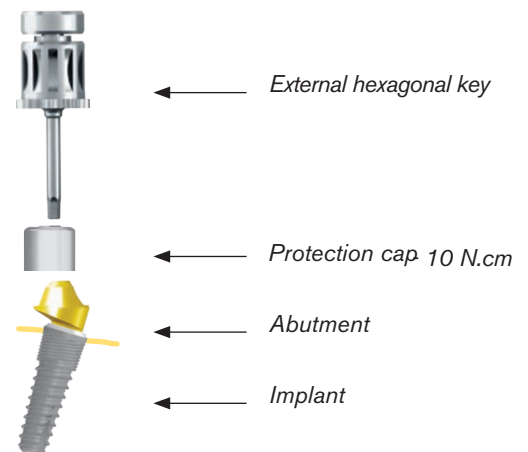

PICTURE 4

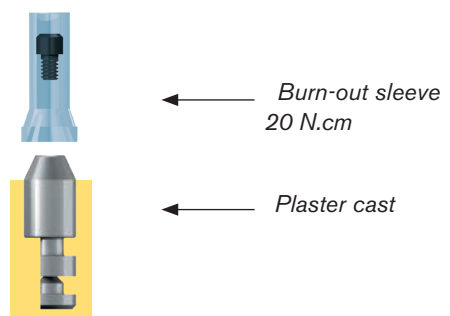



## Screwed prosthesis ON PLURAL ABUTMENTS

### For multi-unit prosthesis on divergent implants

1. Remove the healing abutment and screw the Plural abutments into the implants in the mouth with the external hexagonal key (*ref. CCL HE 12 22*). Tighten the abutment with the torque wrench (*Ref. CCC 35*) at 25 N.cm.
2. Using the same key or manually, screw the pick-up impression copings into the abutments.
3. Take the impression with an open tray.
4. Unscrew the impression copings and connect the analogs into the impression copings, (the analog replicates the implant topped by a Plural abutment). (see picture 2)
5. At this stage a protection cap can be used as a temporary cover for the implants. A temporary prosthesis can be fabricated on the protection cap or directly onto the temporary abutments screwed onto the plural abutments. Screwing of temporary abutments at 20 N.cm.
6. Send the impression to the laboratory.
7. The plaster cast model is made at laboratory.
8. The burn-out sleeves are fixed on the analogs. (see picture 4)
9. Fabricate the prosthesis and thoroughly clear the access screw.
10. Try in the mouth, check and adjust occlusion.
11. Finish the prosthesis.
12. Final adjustment of the prosthesis.
13. Passive insertion and tighten on the Plural abutments in the mouth with the torque wrench (*Ref. CCC 35*) at 25 N.cm. Seal the screw heads and access holes. (see picture 5)



*Do not use the final abutment screw in the lab or for trying of the prosthesis; this would damage the physical properties. For try-ins and laboratory work use lab guide screw ref. NPV VG 18 105. For final fixing in the mouth use a new abutment screw.*

**Screwed prosthesis ON PLURAL STRAIGHT ABUTMENTS**

PICTURE 1. SCREWING THE IMPRESSION COPING

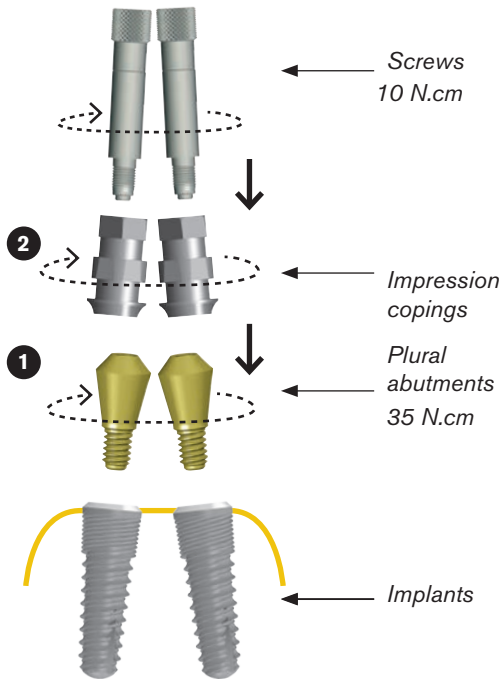

PICTURE 2. CONNECTING THE ANALOG

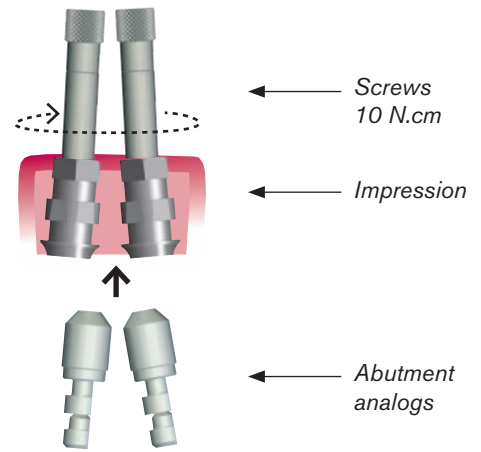

PICTURE 3. PROTECTION CAP

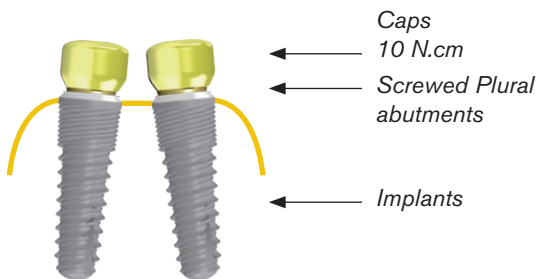

PICTURE 4. ON THE PLASTER CAST MODEL

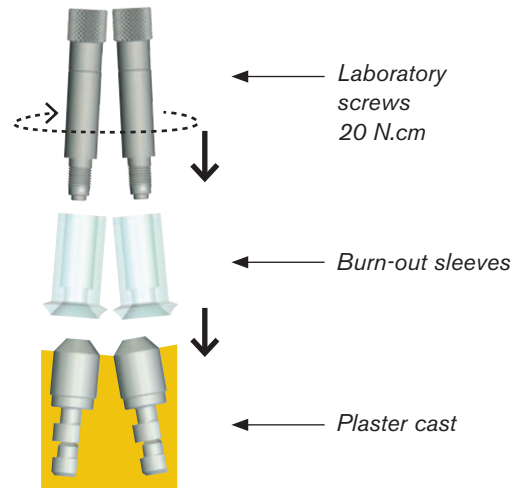

PICTURE 5. IN THE MOUTH

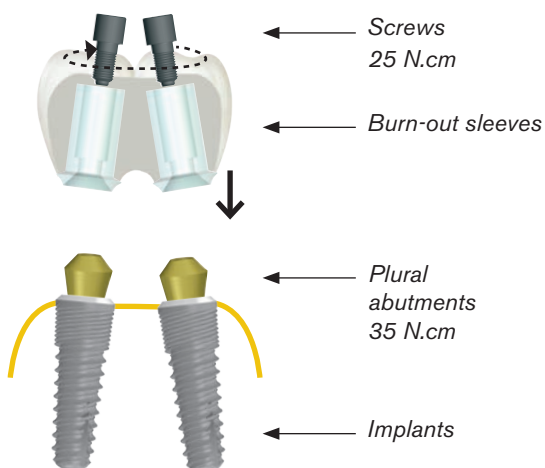

## Screwed prosthesis ON PLURAL ANGULATED ABUTMENTS

PICTURE 1. SCREWING THE IMPRESSION COPINGS

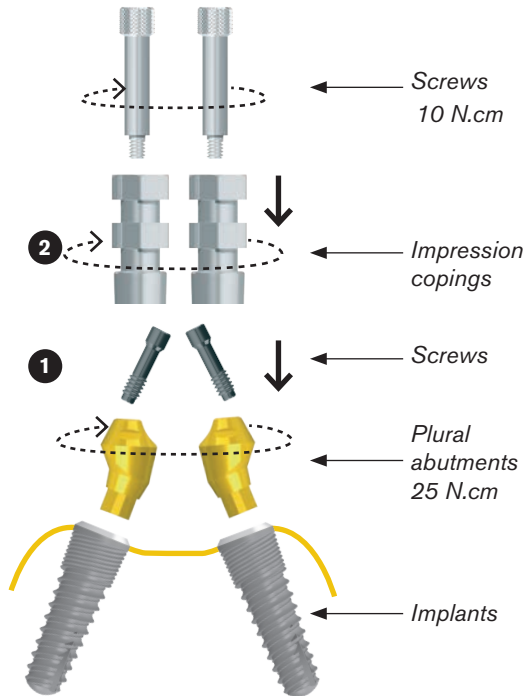

PICTURE 2. CONNECTING THE ANALOGS

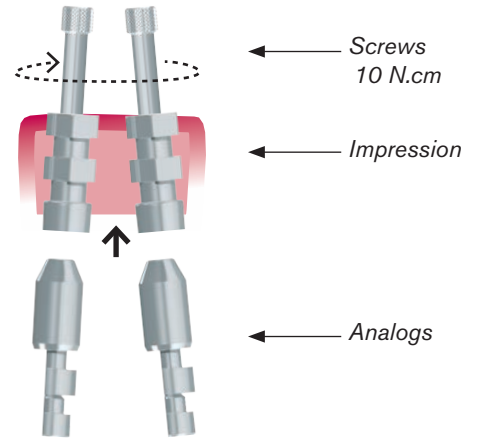

PICTURE 3. PROTECTION CAPS

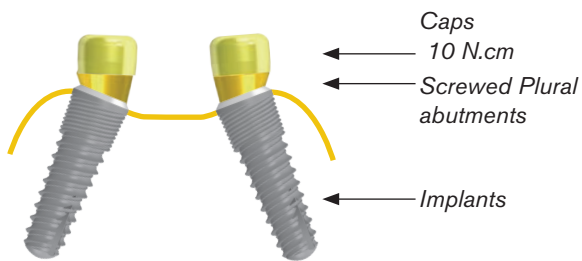

PICTURE 4. ON THE PLASTER CAST MODEL

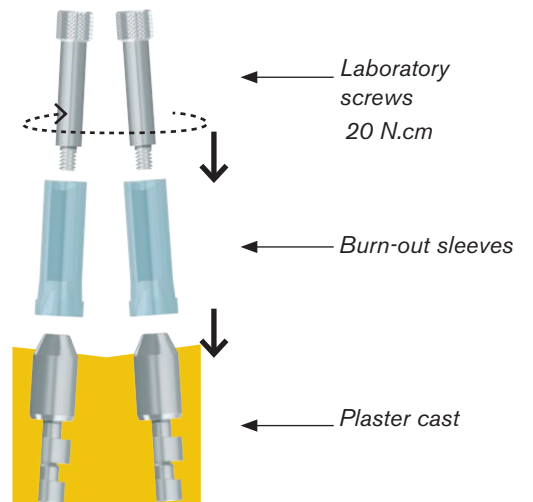

PICTURE 5. IN THE MOUTH

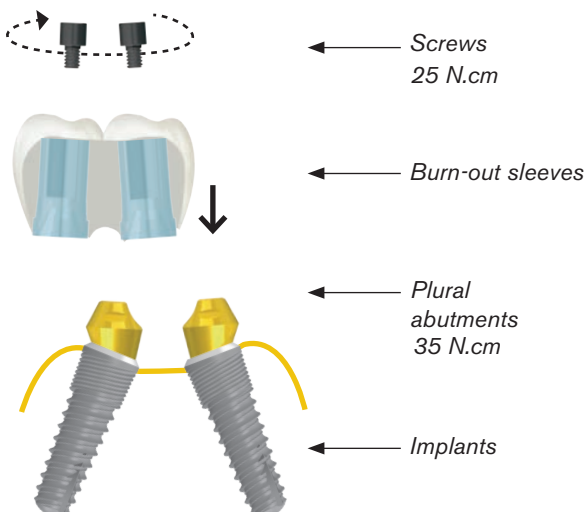



# OVERDENTURE ON O’RING ABUTMENTS

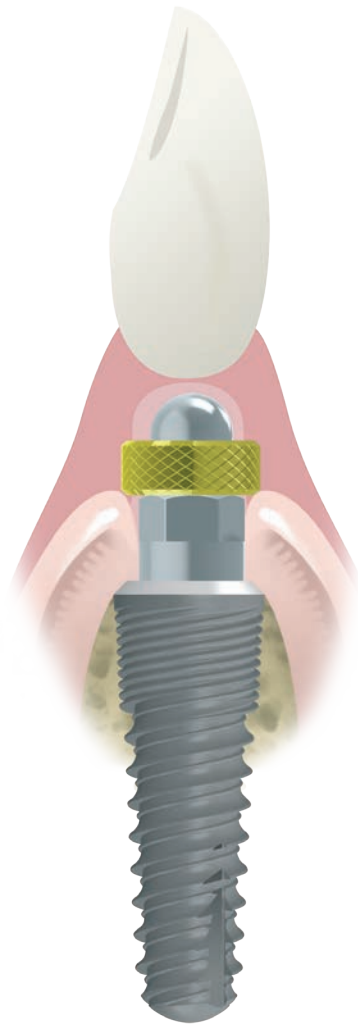

**For removable prosthesis  
WITH BALL ABUTMENTS**

1. Screw manually or with the external hexagonal key the impression copings into the implants for taking the impressions.
  2. Unscrew the impression coping to remove the impression.
  3. Connect the analogs to the impression coping (see picture 2).
  4. Send the impression to the laboratory which fabricates the plaster cast model.
  5. Screw the O'Ring abutments into the implant analogs on the model. Use the internal hexagonal O'Ring key (Ref. CCL HI 25 26) (see picture 3).
  6. The O'Ring attachments are snapped onto the O'Ring abutments.
  7. Process the overdenture in resin on a wax up as for a normal full denture.
  8. Attach the O'Ring attachments into the acrylic base of the overdenture.
  9. Reline the overdenture and adjust the occlusion.
  10. Final fixing - Screw the O'Ring abutments into the implant with the torque wrench (Ref. CCC 35) at 35 N.cm.
- The overdenture can now snap onto the balls. Re check the mucosal support.



*It is also possible to take the impression on the ball abutment, so the impression coping is not necessary. In this case, use ball abutment analog (ref. OPS HOBI).*

PICTURE 1. SCREWING IMPRESSION COPING

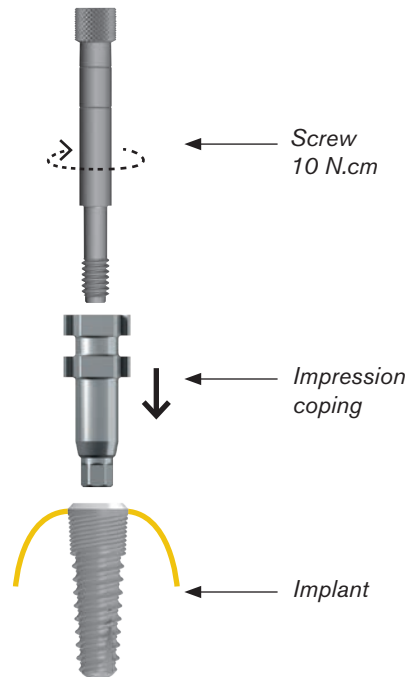

PICTURE 2. CONNECTING THE ANALOG

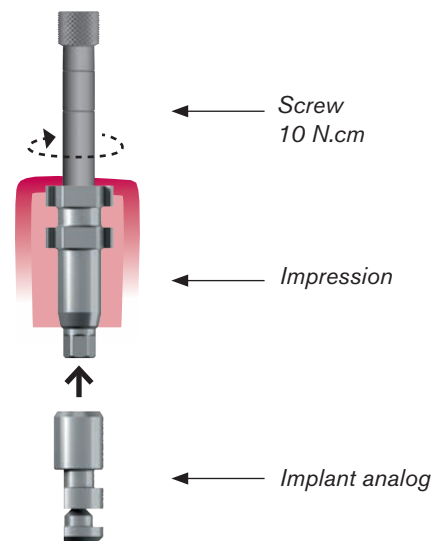

PICTURE 3. ON PLASTER CAST

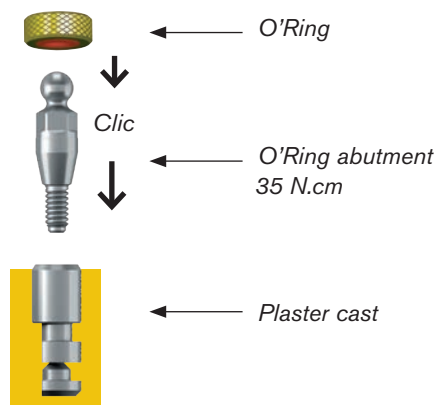



## Studies & PUBLICATIONS

- Placement of implants in the mandible reconstructed with free vascularized fibula flap: comparison of 2 cases with Aesthetica+ implants - University of Cukurova (Turkey) – 2008
- Slim implants for complete denture wearers: clinical aspects and perspectives with OBI implants – University of Auvergne (Clermont-Ferrand - France) – 2013
- Placement of Naturactis implants in post-extraction sites – University of Madrid (Spain) - 2013
- Contribution of a hybrid synthetic and innovating product in the bone surgery and its filling Matri™ BONE with Natea and Naturall implants - University Henry Poincarre (Nancy - France) – 2012
- Implant-supported prosthetic solution in case of small inter alveolar distance on Aesthetica+ implants – Polyclinic Kiev (Ukraine) – 2009
- Histology and histomorphometry – Comparative study with the Universal and Brånemark implants – Angers Histological Laboratory (France) – 1993
- Multicentric study on the evolution of 3000 euroteknika and Nobel Biocare implants from 1984 to 1997 – comparison of the results - Faculty of Medicine of Angers (France) – 1997
- Quantitative study on the rough surfaces of titanium dental implants and their microstructures – University Henry Poincarre (Nancy - France) – 2011
- Analysis of the surface treatment of euroteknika and competitor implants – University of Barcelona (Spain) – 2006
- Evaluation of the euroteknika implant microfiltration – University of Catalonia (Spain) – 2008
- Comparison between the digital planning and the final position of the implants with the teknika3D system – University of Bordeaux (France) – 2013
- Resonance frequency analysis, insertion torque and BIC of 4 implants: comparison and correlation study in sheep - University Saint Joseph (Libanon)
- Comparison of two types of decalcified freeze-dried bone allograft in treatment of dehiscence defects around Natea implants in dogs – University of Iran – 2011
- Comparison of the insertion and desinsertion torque of a cylindrical and a tapered implant in 3 different materials – University of Catalonia (Spain) – 2008

Download  
the full studies



Nancy-Université  
Université  
Henri Poincaré



Université  
d'Auvergne



UNIVERSITÉ  
BORDEAUX  
S E G A L E N

Inserm

Université Saint-Joseph  
Beyrouth - Liban



UNIVERSIDAD  
COMPLUTENSE  
MADRID